

# Appendix A. PDS Data Object Definitions

This section provides an alphabetical reference of approved PDS data object definitions used for labeling primary and secondary data objects. The definitions include descriptions, lists of required and optional keywords, lists of required and optional subobjects (or child objects), and one or more examples of specific objects. For a more detailed discussion on primary and secondary data objects, see the *Data Products* chapter in this document.

Data object definitions are refined and augmented from time to time, as user community needs arise, so object definitions for products designed under older versions of the Standards may differ significantly. To check the current state of any object definition, consult a PDS data engineer or either of these URLs:

PDS Catalog Search: <http://pdsproto.jpl.nasa.gov/onlinecatalog/top.cfm>

Data Dictionary Search: <http://pdsproto.jpl.nasa.gov/ddcolstdval/newdd/top.cfm>

The examples provided in this Appendix are based on both existing and planned PDS archive products, modified to reflect the current version of the PDS Standards. Additional examples may be obtained by contacting a PDS Data Engineer.

NOTE: Any keywords in the *Planetary Science Data Dictionary* may also be included in a specific data object definition.

## *Primitive Objects*

There exist four primitive data objects: ARRAY; BIT\_ELEMENT; COLLECTION; and ELEMENT. Although these objects are available, they should only be used after careful consideration of the current high-level PDS Data Objects. Please see the *PDS Objects* chapter in this document for guidelines on the use of primitive objects.

## Chapter Contents

Appendix A.	PDS Data Object Definitions .....	A-1
A.1	ALIAS .....	A-3
A.2	ARRAY (Primitive Data Object).....	A-4
A.3	BIT_COLUMN .....	A-8
A.4	BIT ELEMENT (Primitive Data Object) .....	A-11
A.5	CATALOG .....	A-12
A.6	COLLECTION (Primitive Data Object) .....	A-15
A.7	COLUMN .....	A-16
A.8	CONTAINER .....	A-20
A.9	DATA_PRODUCER .....	A-27
A.10	DATA_SUPPLIER .....	A-29
A.11	DIRECTORY.....	A-31
A.12	DOCUMENT .....	A-33
A.13	ELEMENT (Primitive Data Object) .....	A-36
A.14	FIELD.....	A-38
A.15	FILE .....	A-41
A.16	GAZETTEER_TABLE .....	A-45
A.17	HEADER .....	A-55
A.18	HISTOGRAM.....	A-57
A.19	HISTORY .....	A-60
A.20	IMAGE .....	A-64
A.21	INDEX_TABLE .....	A-69
A.22	PALETTE.....	A-74
A.23	QUBE .....	A-77
A.24	SERIES.....	A-85
A.25	SPECTRAL_QUBE.....	A-90
A.26	SPECTRUM .....	A-109
A.27	SPICE KERNEL .....	A-112
A.28	SPREADSHEET .....	A-115
A.29	TABLE .....	A-120
A.30	TEXT .....	A-141
A.31	VOLUME .....	A-143

## A.1 ALIAS

The ALIAS object provides a method for identifying alternate terms or names for approved data elements or objects within a data system. The ALIAS object is an optional sub-object of the COLUMN object.

### A.1.1 Required Keywords

1. ALIAS\_NAME
2. USAGE\_NOTE

### A.1.2 Optional Keywords

Any

### A.1.3 Required Objects

None

### A.1.4 Optional Objects

None

### A.1.5 Example

The following label fragment shows the ALIAS object included as a sub-object of a COLUMN:

```

OBJECT          = COLUMN
  NAME          = ALT_FOOTPRINT_LONGITUDE
  START_BYTE    = 1
  DATA_TYPE    = REAL
  BYTES         = 10

OBJECT          = ALIAS
  ALIAS_NAME    = AR_LON
  USAGE_NOTE    = "MAGELLAN MIT ARCDR SIS"
  END_OBJECT    = ALIAS
END_OBJECT      = COLUMN

```

## A.2 ARRAY (Primitive Data Object)

The ARRAY object is provided to describe dimensioned arrays of homogeneous objects. Note that an ARRAY may contain only a single sub-object, which can itself be another ARRAY or COLLECTION if required. A maximum of 6 axes is allowed in an ARRAY. By default, the rightmost axis is the fastest varying axis.

The optional “AXIS\_\*” elements are used to describe the variation between successive objects in the ARRAY. Values for AXIS\_ITEMS and “AXIS\_\*” elements for multidimensional arrays are listed in axis order. The optional START\_BYTE data element provides the starting location relative to an enclosing object. If a START\_BYTE is not specified, a value of 1 is assumed.

### A.2.1 Required Keywords

1. AXES
2. AXIS\_ITEMS
3. NAME

### A.2.2 Optional Keywords

1. AXIS\_INTERVAL
2. AXIS\_NAME
3. AXIS\_UNIT
4. AXIS\_START
5. AXIS\_STOP
6. AXIS\_ORDER\_TYPE
7. CHECKSUM
8. DESCRIPTION
9. INTERCHANGE\_FORMAT
10. START\_BYTE

### A.2.3 Required Objects

None

Note that while no specific sub-object is required, the ARRAY object must contain at least one of the optional objects, following. That is, a null ARRAY object may not be defined.

## A.2.4 Optional Objects

1. ARRAY
2. BIT\_ELEMENT
3. COLLECTION
4. ELEMENT

## A.2.5 Example 1

Following is an example of a two-dimensional spectrum array in a detached label.

```

PDS_VERSION_ID          = PDS3
RECORD_TYPE             = FIXED_LENGTH
RECORD_BYTES           = 1600
FILE_RECORDS           = 180

DATA_SET_ID             = "IHW-C-SPEC-2-EDR-HALLEY-V1.0"
OBSERVATION_ID         = "704283"
TARGET_NAME            = "HALLEY"
INSTRUMENT_HOST_NAME   = "IHW SPECTROSCOPY AND SPECTROPHOTOMETRY
                          NETWORK"
INSTRUMENT_NAME        = "IHW SPECTROSCOPY AND SPECTROPHOTOMETRY"
PRODUCT_ID             = "704283"
OBSERVATION_TIME       = 1986-05-09T04:10:20.640
START_TIME             = 1986-05-09T04:07:50.640
STOP_TIME              = UNK
PRODUCT_CREATION_TIME  = 1993-01-01T00:00:00.000
^ARRAY                 = "SPEC2702.DAT"

/* Description of Object in File */

OBJECT                  = ARRAY
  NAME                  = "2D SPECTRUM"
  INTERCHANGE_FORMAT   = BINARY
  AXES                  = 2
  AXIS_ITEMS           = (180,800)
  AXIS_NAME            = ("RHO", "APPROXIMATE WAVELENGTH")
  AXIS_UNIT            = (ARCSEC,ANGSTROMS)
  AXIS_INTERVAL        = (1.5,7.2164)
  AXIS_START           = (1.0,5034.9)

OBJECT                  = ELEMENT
  DATA_TYPE           = MSB_INTEGER
  BYTES                = 2
  NAME                 = COUNT
  DERIVED_MAXIMUM      = 2.424980E+04
  DERIVED_MINIMUM      = 0.000000E+00
  OFFSET               = 0.000000E+00
  SCALING_FACTOR       = 1.000000E+00

```

```

NOTE = "Conversion factor 1.45 may be applied
      to data to estimate photons/sq
      m/sec/angstrom at 6800 angstroms."
END_OBJECT = ELEMENT
END_OBJECT = ARRAY
END

```

## A.2.6 Example 2

The following label shows ARRAY, COLLECTION and ELEMENT primitive objects all used together.

```

PDS_VERSION_ID = PDS3
RECORD_TYPE = FIXED_LENGTH
RECORD_BYTES = 122
FILE_RECORDS = 7387

^ARRAY = "MISCHA01.DAT"

DATA_SET_ID = "VEGA1-C-MISCHA-3-RDR-HALLEY-V1.0"
TARGET_NAME = HALLEY
SPACECRAFT_NAME = "VEGA 1"
INSTRUMENT_NAME = "MAGNETOMETER"
PRODUCT_ID = "XYZ"
START_TIME = "UNK"
STOP_TIME = "UNK"
SPACECRAFT_CLOCK_START_COUNT = "UNK"
SPACECRAFT_CLOCK_STOP_COUNT = "UNK"

NOTE = "VEGA 1 MISCHA DATA"

OBJECT = ARRAY
  NAME = MISCHA_DATA_FILE
  INTERCHANGE_FORMAT = BINARY
  AXES = 1
  AXIS_ITEMS = 7387
  DESCRIPTION = "This file contains an array of fixed-
                length Mischa records."

OBJECT = COLLECTION
  NAME = MISCHA_RECORD
  BYTES = 122
  DESCRIPTION = "Each record in this file consists of a
                time tag followed by a 20-element array
                of magnetic field vectors."

OBJECT = ELEMENT
  NAME = START_TIME
  BYTES = 2
  DATA_TYPE = MSB_INTEGER
  START_BYTE = 1
  END_OBJECT = ELEMENT

```

```

OBJECT          = ARRAY
  NAME          = MAGNETIC_FIELD_ARRAY
  AXES          = 2
  AXIS_ITEMS    = ( 3, 20 )
  START_BYTE    = 3
  AXIS_NAME     = ( "XYZ_COMPONENT", "TIME" )
  AXIS_UNIT     = ( "N/A"           , "SECOND" )
  AXIS_INTERVAL = ( "N/A"           , 0.2 )
  DESCRIPTION   = "Magnetic field vectors were recorded at
                  the rate of 10 per second. The
                  START_TIME field gives the time at
                  which the first vector in the record
                  was recorded. Successive vectors were
                  recorded at 0.2 second intervals."

OBJECT          = ELEMENT
  NAME          = MAG_FIELD_COMPONENT_VALUE
  BYTES         = 2
  DATA_TYPE    = MSB_INTEGER
  START_BYTE    = 1
  END_OBJECT    = ELEMENT
END_OBJECT     = ARRAY

END_OBJECT     = COLLECTION

END_OBJECT     = ARRAY
END

```

## A.3 BIT\_COLUMN

The BIT\_COLUMN object identifies a string of bits that do not fall on even byte boundaries and therefore cannot be described as a distinct COLUMN. BIT\_COLUMNS defined within columns are analogous to columns defined within rows.

Notes:

- (1) The Planetary Data System recommends that all fields (within new objects) be defined on byte boundaries. This precludes having multiple values strung together in bit strings, as occurs in the BIT\_COLUMN object.
- (2) BIT\_COLUMN is intended for use in describing existing binary data strings, but is not recommended for use in defining new data objects because it will not be recognized by most general purpose software.
- (3) A BIT\_COLUMN must not contain embedded objects.

BIT\_COLUMNS of the same format and size may be specified as a single BIT\_COLUMN by using the ITEMS, ITEM\_BITS, and ITEM\_OFFSET elements. The ITEMS data element is used to indicate the number of occurrences of a bit string.

### A.3.1 Required Keywords

1. NAME
2. BIT\_DATA\_TYPE
3. START\_BIT
4. BITS (required for BIT\_COLUMNS without items)
5. DESCRIPTION

### A.3.2 Optional Keywords

1. BIT\_MASK
2. BITS (optional for BIT\_COLUMNSs with ITEMS)
3. FORMAT
4. INVALID\_CONSTANT
5. ITEMS
6. ITEM\_BITS
7. ITEM\_OFFSET
8. MINIMUM
9. MAXIMUM
10. MISSING\_CONSTANT
11. OFFSET



## 12. SCALING\_FACTOR

## 13. UNIT

**A.3.3 Required Objects**

None

**A.3.4 Optional Objects**

None

**A.3.5 Example**

The label fragment below was extracted from a larger example which can be found under the CONTAINER object. The BIT\_COLUMN object can be a sub-object only of a COLUMN object, but that COLUMN may itself be part of a TABLE, SPECTRUM, SERIES or CONTAINER object.

---

```

OBJECT          = COLUMN
  NAME          = PACKET_ID
  DATA_TYPE    = LSB_BIT_STRING
  START_BYTE    = 1
  BYTES         = 2
  VALID_MINIMUM = 0
  VALID_MAXIMUM = 7
  DESCRIPTION   = "Packet_id constitutes one of three
                  parts in the primary source information
                  header applied by the Payload Data
                  System (PDS) to the MOLA telemetry
                  packet at the time of creation of the
                  packet prior to transfer frame
                  creation."

OBJECT          = BIT_COLUMN
  NAME          = VERSION_NUMBER
  BIT_DATA_TYPE = MSB_UNSIGNED_INTEGER
  START_BIT     = 1
  BITS          = 3
  MINIMUM       = 0
  MAXIMUM       = 7
  DESCRIPTION   = "These bits identify Version 1 as the
                  Source Packet structure.  These bits
                  shall be set to '000'."

END_OBJECT     = BIT_COLUMN

OBJECT          = BIT_COLUMN

```

```

NAME = SPARE
BIT_DATA_TYPE = MSB_UNSIGNED_INTEGER
START_BIT = 4
BITS = 1
MINIMUM = 0
MAXIMUM = 0
DESCRIPTION = "Reserved spare. This bit shall be set
to '0'"
END_OBJECT = BIT_COLUMN

OBJECT = BIT_COLUMN
NAME = FLAG
BIT_DATA_TYPE = BOOLEAN
START_BIT = 5
BITS = 1
MINIMUM = 0
MAXIMUM = 0
DESCRIPTION = "This flag signals the presence or
absence of a Secondary Header data
structure within the Source Packet.
This bit shall be set to '0' since no
Secondary Header formatting standards
currently exist for Mars Observer."
END_OBJECT = BIT_COLUMN

OBJECT = BIT_COLUMN
NAME = ERROR_STATUS
BIT_DATA_TYPE = MSB_UNSIGNED_INTEGER
START_BIT = 6
BITS = 3
MINIMUM = 0
MAXIMUM = 7
DESCRIPTION = "This field identifies in part the
individual application process within
the spacecraft that created the Source
Packet data."
END_OBJECT = BIT_COLUMN

OBJECT = BIT_COLUMN
NAME = INSTRUMENT_ID
BIT_DATA_TYPE = MSB_UNSIGNED_INTEGER
START_BIT = 9
BITS = 8
MINIMUM = "N/A"
MAXIMUM = "N/A"
DESCRIPTION = "This field identifies in part the
individual application process within
the spacecraft that created the Source
Packet data. 00100011 is the bit
pattern for MOLA."
END_OBJECT = BIT_COLUMN
END_OBJECT = COLUMN

```

## **A.4 BIT ELEMENT (Primitive Data Object)**

Under review.

## A.5 CATALOG

The CATALOG object is used within a VOLUME object to reference the completed PDS high-level catalog object set. The catalog object set provides additional information related to the data sets on a volume. Please refer to the *File Specification and Naming* chapter in this document for more information.

### A.5.1 Required Keywords

None

### A.5.2 Optional Keywords

1. DATA\_SET\_ID
2. LOGICAL\_VOLUME\_PATHNAME
3. LOGICAL\_VOLUMES

### A.5.3 Required Objects

1. DATA\_SET
2. INSTRUMENT
3. INSTRUMENT\_HOST
4. MISSION

### A.5.4 Optional Objects

1. DATA\_SET\_COLLECTION
2. PERSONNEL
3. REFERENCE
4. TARGET

### A.5.5 Example

The example below is a VOLDESC.CAT file for a volume containing multiple data sets. In this case, the catalog objects are provided in separate files referenced by pointers.

```

PDS_VERSION_ID           = PDS3
LABEL_REVISION_NOTE      = "1998-07-01, S. Joy (PPI) ;"
RECORD_TYPE              = STREAM

OBJECT                    = VOLUME

```

```

VOLUME_SERIES_NAME      = "VOYAGERS TO THE OUTER PLANETS"
VOLUME_SET_NAME         = "VOYAGER NEPTUNE PLANETARY PLASMA
                           INTERACTIONS DATA"
VOLUME_SET_ID           = USA_NASA_PDS_VG_1001
VOLUMES                  = 1
VOLUME_NAME             = "VOYAGER NEPTUNE PLANETARY PLASMA
                           INTERACTIONS DATA"
VOLUME_ID               = VG_1001
VOLUME_VERSION_ID       = "VERSION 1"
VOLUME_FORMAT           = "ISO-9660"
MEDIUM_TYPE             = "CD-ROM"
PUBLICATION_DATE        = 1992-11-13
DESCRIPTION              = "This volume contains a collection of
                           non-imaging Planetary Plasma datasets
                           from the Voyager 2 spacecraft encounter
                           with Neptune.  Included are datasets
                           from the Cosmic Ray System (CRS),
                           Plasma System (PLS), Plasma Wave System
                           (PWS), Planetary Radio Astronomy (PRA),
                           Magnetometer (MAG), and Low Energy
                           Charged Particle (LECP) instruments, as
                           well as spacecraft position vectors
                           (POS) in several coordinate systems.
                           The volume also contains documentation
                           and index files to support access and
                           use of the data."

DATA_SET_ID             = { "VG2-N-CRS-3-RDR-D1-6SEC-V1.0",
                           "VG2-N-CRS-4-SUMM-D1-96SEC-V1.0",
                           "VG2-N-CRS-4-SUMM-D2-96SEC-V1.0",
                           "VG2-N-LECP-4-SUMM-SCAN-24SEC-V1.0",
                           "VG2-N-LECP-4-RDR-STEP-12.8MIN-V1.0",
                           "VG2-N-MAG-4-RDR-HG-COORDS-1.92SEC-V1.0",
                           "VG2-N-MAG-4-SUMM-HG-COORDS-48SEC-V1.0",
                           "VG2-N-MAG-4-RDR-HG-COORDS-9.6SEC-V1.0",
                           "VG2-N-MAG-4-SUMM-NLSCOORDS-12SEC-V1.0",
                           "VG2-N-PLS-5-RDR-2PROMAGSPH-48SEC-V1.0",
                           "VG2-N-PLS-5-RDR-ELEMAGSPHERE-96SEC-V1.0",
                           "VG2-N-PLS-5-RDR-IONMAGSPHERE-48SEC-V1.0",
                           "VG2-N-PLS-5-RDR-IONLMODE-48SEC-V1.0",
                           "VG2-N-PLS-5-RDR-IONMMODE-12MIN-V1.0",
                           "VG2-N-PLS-5-RDR-ION-INBNDWIND-48SEC-V1.0",
                           "VG2-N-POS-5-RDR-HGHGCOORDS-48SEC-V1.0",
                           "VG2-N-POS-5-SUMM-NLSCOORDS-12-48SEC-V1.0",
                           "VG2-N-PRA-4-SUMM-BROWSE-SEC-V1.0",
                           "VG2-N-PRA-2-RDR-HIGHRATE-60MS-V1.0",
                           "VG2-N-PWS-2-RDR-SA-4SEC-V1.0",
                           "VG2-N-PWS-4-SUMM-SA-48SEC-V1.0",
                           "VG2-N-PWS-1-EDR-WFRM-60MS-V1.0" }

OBJECT                  = DATA_PRODUCER
  INSTITUTION_NAME      = "UNIVERSITY OF CALIFORNIA, LOS ANGELES"
  FACILITY_NAME         = "PDS PLANETARY PLASMA INTERACTIONS NODE"
  FULL_NAME             = "DR. RAYMOND WALKER"

```

```

DISCIPLINE_NAME      = "PLASMA INTERACTIONS"
ADDRESS_TEXT         = "UCLA
                        IGPP
                        LOS ANGELES, CA 90024 USA"
END_OBJECT           = DATA_PRODUCER

OBJECT               = DATA_SUPPLIER
  INSTITUTION_NAME   = "NATIONAL SPACE SCIENCE DATA CENTER"
  FACILITY_NAME      = "NATIONAL SPACE SCIENCE DATA CENTER"
  FULL_NAME          = "NATIONAL SPACE SCIENCE DATA CENTER"
  DISCIPLINE_NAME    = "NATIONAL SPACE SCIENCE DATA CENTER"
  ADDRESS_TEXT       = "Code 633 \n
                        Goddard Space Flight Center \n
                        Greenbelt, Maryland, 20771, USA"
  TELEPHONE_NUMBER   = "3012866695"
  ELECTRONIC_MAIL_TYPE = "NSI/DECNET"
  ELECTRONIC_MAIL_ID  = "NSSDCA::REQUEST"
END_OBJECT           = DATA_SUPPLIER

OBJECT               = CATALOG
  ^MISSION_CATALOG   = "MISSION.CAT"
  ^INSTRUMENT_HOST_CATALOG = "INSTHOST.CAT"
  ^INSTRUMENT_CATALOG = { "CRS_INST.CAT",
                          "LECPINST.CAT",
                          "MAG_INST.CAT",
                          "PLS_INST.CAT",
                          "PRA_INST.CAT",
                          "PWS_INST.CAT" }
  ^DATA_SET_CATALOG  = { "CRS_DS.CAT",
                          "LECP_DS.CAT",
                          "MAG_DS.CAT",
                          "PLS_DS.CAT",
                          "POS_DS.CAT",
                          "PRA_DS.CAT",
                          "PWS_DS.CAT" }
  ^TARGET_CATALOG    = TARGET.CAT
  ^PERSONNEL_CATALOG = PERSON.CAT
  ^REFERENCE_CATALOG = REF.CAT
END_OBJECT           = CATALOG

END_OBJECT           = VOLUME
END

```

## A.6 COLLECTION (Primitive Data Object)

The COLLECTION object allows the ordered grouping of heterogeneous objects into a structure. The COLLECTION object may contain a mixture of different object types, including other COLLECTIONs. The optional START\_BYTE data element provides the starting location relative to an enclosing object. If a START\_BYTE is not specified, a value of 1 is assumed.

### A.6.1 Required Keywords

1. BYTES
2. NAME

### A.6.2 Optional Keywords

1. DESCRIPTION
2. CHECKSUM
3. INTERCHANGE\_FORMAT
4. START\_BYTE

### A.6.3 Required Objects

None

Note that although a specific sub-object is not required, the COLLECTION must contain at least one of the optional objects listed following. That is, a null COLLECTION may not be defined.

### A.6.4 Optional Objects

1. ELEMENT
2. BIT\_ELEMENT
3. ARRAY
4. COLLECTION

### A.6.5 Example

Please refer to Section A.2.6, *Example 2* under the ARRAY object for an illustration of the COLLECTION object used in conjunction with other primitive objects.

## A.7 COLUMN

The COLUMN object identifies a single column in a data object.

Notes:

- (1) Current PDS data objects that include COLUMN objects are the TABLE, CONTAINER, SPECTRUM and SERIES objects.
- (2) COLUMNS must not themselves contain embedded COLUMN objects.
- (3) COLUMNS of the same format and size which constitute a vector may be specified as a single COLUMN by using the ITEMS, ITEM\_BYTES, and ITEM\_OFFSET elements. The ITEMS data element indicates the number of occurrences of the field (i.e., elements in the vector).
- (4) BYTES and ITEM\_BYTES counts do not include leading or trailing delimiters or line terminators.
- (5) For a COLUMN containing ITEMS, the value of BYTES should represent the total size of the column including delimiters between the items. (See examples 1 and 2 below.)

### A.7.1 Required Keywords

1. NAME
2. DATA\_TYPE
3. START\_BYTE
4. BYTES (required for COLUMNS without ITEMS)

### A.7.2 Optional Keywords

1. BIT\_MASK
2. BYTES (optional for COLUMNS with ITEMS)
3. COLUMN\_NUMBER
4. DERIVED\_MAXIMUM
5. DERIVED\_MINIMUM
6. DESCRIPTION
7. FORMAT
8. INVALID\_CONSTANT
9. ITEM\_BYTES
10. ITEM\_OFFSET
11. ITEMS
12. MAXIMUM
13. MAXIMUM\_SAMPLING\_PARAMETER
14. MINIMUM
15. MINIMUM\_SAMPLING\_PARAMETER



16. MISSING\_CONSTANT
17. OFFSET
18. SAMPLING\_PARAMETER\_INTERVAL
19. SAMPLING\_PARAMETER\_NAME
20. SAMPLING\_PARAMETER\_UNIT
21. SCALING\_FACTOR
22. UNIT
23. VALID\_MAXIMUM
24. VALID\_MINIMUM

### A.7.3 Required Objects

None

### A.7.4 Optional Objects

1. BIT\_COLUMN
2. ALIAS

### A.7.5 Example 1

The label fragment below shows a simple COLUMN object, in this case from an ASCII TABLE.

```

OBJECT                = COLUMN
  NAME                = "DETECTOR TEMPERATURE"
  START_BYTE         = 27
  BYTES              = 5
  DATA_TYPE         = ASCII_REAL
  FORMAT             = "F5.1"
  UNIT               = "KELVIN"
  MISSING_CONSTANT   = 999.9
  END_OBJECT         = COLUMN

```

### A.7.6 Example 2

The fragment below shows two COLUMNS containing multiple items. The first COLUMN is a vector containing three ASCII\_INTEGER items: xx, yy, zz. The second COLUMN contains three character items: "xx", "yy" and "zz". Note that the value of BYTES includes the comma delimiters between items, but the ITEM\_BYTES value does not. The ITEM\_OFFSET is the number of bytes from the beginning of one item to the beginning of the next.

```

OBJECT                = COLUMN
  NAME                = COLUMN1XYZ
  DATA_TYPE         = ASCII_INTEGER

```

```

START_BYTE           = 1
BYTES                = 8 /*includes delimiters*/
ITEMS                = 3
ITEM_BYTES           = 2
ITEM_OFFSET          = 3
END_OBJECT           = COLUMN

OBJECT               = COLUMN
NAME                 = COLUMN2XYZ
DATA_TYPE            = CHARACTER
START_BYTE           = 2 /* value does not include leading quote */
BYTES                = 12 /* value does not include leading and */
                    /* trailing quotes */
ITEMS                = 3
ITEM_BYTES           = 2 /* value does not include leading and */
                    /* trailing quotes */
ITEM_OFFSET          = 5 /* value does not include leading quote */
END_OBJECT           = COLUMN

```

### A.7.7 Example 3

The fragment below was extracted from a larger example which can be found under the CONTAINER object. It illustrates a single COLUMN object subdivided into several BIT\_COLUMN fields.

```

OBJECT               = COLUMN
NAME                 = PACKET_ID
DATA_TYPE            = LSB_BIT_STRING
START_BYTE           = 1
BYTES                = 2
VALID_MINIMUM        = 0
VALID_MAXIMUM        = 7
DESCRIPTION           = "Packet_id constitutes one of three
                        parts in the primary source
                        information header applied by the
                        Payload Data System (PDS) to the MOLA
                        telemetry packet at the time of
                        creation of the packet prior to
                        transfer frame creation. "

OBJECT               = BIT_COLUMN
NAME                 = VERSION_NUMBER
BIT_DATA_TYPE        = MSB_UNSIGNED_INTEGER
START_BIT            = 1
BITS                 = 3
MINIMUM              = 0
MAXIMUM              = 7
DESCRIPTION           = "These bits identify Version 1 as the
                        Source Packet structure. These bits
                        shall be set to '000'."

END_OBJECT           = BIT_COLUMN

OBJECT               = BIT_COLUMN

```

```

NAME = SPARE
BIT_DATA_TYPE = MSB_UNSIGNED_INTEGER
START_BIT = 4
BITS = 1
MINIMUM = 0
MAXIMUM = 0
DESCRIPTION = "Reserved spare. This bit shall be set
to '0'"
END_OBJECT = BIT_COLUMN

OBJECT = BIT_COLUMN
NAME = FLAG
BIT_DATA_TYPE = BOOLEAN
START_BIT = 5
BITS = 1
MINIMUM = 0
MAXIMUM = 0
DESCRIPTION = "This flag signals the presence or
absence of a Secondary Header data
structure within the Source Packet.
This bit shall be set to '0' since no
Secondary Header formatting standards
currently exist for Mars Observer."
END_OBJECT = BIT_COLUMN

OBJECT = BIT_COLUMN
NAME = ERROR_STATUS
BIT_DATA_TYPE = MSB_UNSIGNED_INTEGER
START_BIT = 6
BITS = 3
MINIMUM = 0
MAXIMUM = 7
DESCRIPTION = "This field identifies in part the
individual application process within
the spacecraft that created the Source
Packet data."
END_OBJECT = BIT_COLUMN

OBJECT = BIT_COLUMN
NAME = INSTRUMENT_ID
BIT_DATA_TYPE = MSB_UNSIGNED_INTEGER
START_BIT = 9
BITS = 8
MINIMUM = "N/A"
MAXIMUM = "N/A"
DESCRIPTION = "This field identifies in part the
individual application process within
the spacecraft that created the Source
Packet data. 00100011 is the bit
pattern for MOLA."
END_OBJECT = BIT_COLUMN
END_OBJECT = COLUMN

```

## A.8 CONTAINER

The CONTAINER object is used to group a set of sub-objects (such as COLUMNS) that repeat within a data object (such as a TABLE). Use of the CONTAINER object allows repeating groups to be defined within a data structure.

### A.8.1 Required Keywords

1. NAME
2. START\_BYTE
3. BYTES
4. REPETITIONS
5. DESCRIPTION

### A.8.2 Optional Keywords

Any

### A.8.3 Required Objects

None

### A.8.4 Optional Objects

1. COLUMN
2. CONTAINER

### A.8.5 Example

The set of labels and format fragments below illustrates a data product layout in which the CONTAINER object is used. The primary data product is a TABLE of data records. Each record within the TABLE begins with 48 columns (143 bytes) of engineering data. The data product acquires science data from seven different frames. Since the data from each frame are formatted identically, one CONTAINER description suffices for all seven frames.

In this example there are two CONTAINER objects. The first CONTAINER object describes the repeating frame information. Within this CONTAINER there is a second CONTAINER object in which a 4-byte set of three COLUMN objects repeats 20 times. The use of the second CONTAINER object permits the data supplier to describe the three COLUMNS (4 bytes) once, instead of specifying sixty column definitions.

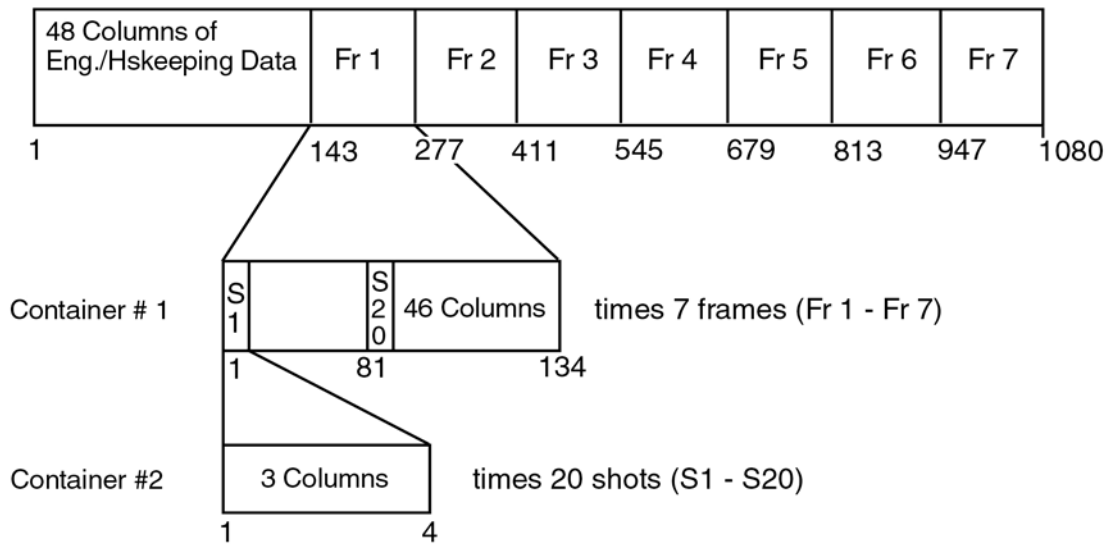

In the first CONTAINER, the keyword REPETITIONS is equal to 7. In the second CONTAINER, REPETITIONS equals 20. Both CONTAINER objects contain a collection of COLUMN objects. In most cases it is preferable to save space in the product label by placing COLUMN objects in a separate file and pointing to that file from within the CONTAINER object.

This attached label example describes the above TABLE structure using CONTAINER objects.

```

PDS_VERSION_ID           = PDS3
RECORD_TYPE              = FIXED_LENGTH
FILE_RECORDS             = 467
RECORD_BYTES            = 1080
LABEL_RECORDS           = 4
FILE_NAME                = "AEDR.A01"

^MOLA_SCIENCE_MODE_TABLE = 5
DATA_SET_ID              = "MO-M-MOLA-1-AEDR-L0-V1.0"
PRODUCT_ID               = "MOLA-AEDR-10010-0001"
SPACECRAFT_NAME          = MARS_OBSERVER
INSTRUMENT_ID           = MOLA
INSTRUMENT_NAME          = MARS_OBSERVER_LASER_ALTIMETER
TARGET_NAME              = MARS
SOFTWARE_NAME            = "BROWSER 17.1"
UPLOAD_ID                = "5.3"
PRODUCT_RELEASE_DATE     = 1994-12-29T02:10:09.321
START_TIME               = 1994-09-29T04:12:43.983
STOP_TIME                = 1994-09-29T06:09:54.221
SPACECRAFT_CLOCK_START_COUNT = "12345"
SPACECRAFT_CLOCK_STOP_COUNT = "12447"
PRODUCT_CREATION_TIME    = 1994-01-29T07:30:333
MISSION_PHASE_NAME       = MAPPING

```

```

ORBIT_NUMBER                = 0001
PRODUCER_ID                 = MO_MOLA_TEAM
PRODUCER_FULL_NAME         = "DAVID E. SMITH"
PRODUCER_INSTITUTION_NAME  = "GODDARD SPACE FLIGHT CENTER"
DESCRIPTION                  = "This data product contains the
    aggregation of MOLA telemetry packets by Orbit.  All Experiment
    Data Record Packets retrieved from the PDB are collected in this
    data product.  The AEDR data product is put together with the
    Project-provided software tool Browser."

OBJECT                      = MOLA_SCIENCE_MODE_TABLE
  INTERCHANGE_FORMAT        = BINARY
  ROWS                      = 463
  COLUMNS                  = 97
  ROW_BYTES                 = 1080
  ^STRUCTURE                = "MOLASCI.FMT"
  DESCRIPTION                = "This table is one of two that describe
    the arrangement of information on the Mars Observer Laser
    Altimeter (MOLA) Aggregated Engineering Data Record (AEDR).  ..."

END_OBJECT                  = MOLA_SCIENCE_MODE_TABLE
...
END

```

#### Contents of the MOLASCI.FMT file:

```

OBJECT                      = COLUMN
  NAME                      = PACKET_ID
  DATA_TYPE                 = LSB_BIT_STRING
  START_BYTE                 = 1
  BYTES                      = 2
  VALID_MINIMUM              = 0
  VALID_MAXIMUM              = 7
  DESCRIPTION                 = "Packet_id constitutes one of three
    parts in the primary source information header applied by the
    Payload Data System (PDS) to the MOLA telemetry packet at the time
    of creation of the packet prior to transfer frame creation."

OBJECT                      = BIT_COLUMN
  NAME                      = VERSION_NUMBER
  BIT_DATA_TYPE              = UNSIGNED_INTEGER
  START_BIT                  = 1
  BITS                      = 3
  MINIMUM                    = 0
  MAXIMUM                    = 7
  DESCRIPTION                 = "These bits identify Version 1 as the
    Source Packet structure.  These bits shall be set to '000'."
END_OBJECT                  = BIT_COLUMN

OBJECT                      = BIT_COLUMN
  NAME                      = SPARE
  BIT_DATA_TYPE              = UNSIGNED_INTEGER

```

```

START_BIT           = 4
BITS                = 1
MINIMUM             = 0
MAXIMUM             = 0
DESCRIPTION         = "Reserved spare.  This bit shall be set
                      to '0'"
END_OBJECT          = BIT_COLUMN

OBJECT              = BIT_COLUMN
NAME                = SECONDARY_HEADER_FLAG
BIT_DATA_TYPE      = BOOLEAN
START_BIT           = 5
BITS                = 1
MINIMUM             = 0
MAXIMUM             = 0
DESCRIPTION         = "This flag signals the presence or
                      absence of a Secondary Header data structure within the Source
                      Packet.  This bit shall be set to '0' since no Secondary Header
                      formatting standards currently exist for Mars Observer."
END_OBJECT          = BIT_COLUMN

OBJECT              = BIT_COLUMN
NAME                = ERROR_STATUS
BIT_DATA_TYPE      = UNSIGNED_INTEGER
START_BIT           = 6
BITS                = 3
MINIMUM             = 0
MAXIMUM             = 7
DESCRIPTION         = "This field identifies in part the
                      individual application process within the spacecraft that created
                      the Source Packet data."
END_OBJECT          = BIT_COLUMN

OBJECT              = BIT_COLUMN
NAME                = INSTRUMENT_ID
BIT_DATA_TYPE      = UNSIGNED_INTEGER
START_BIT           = 9
BITS                = 8
MINIMUM             = 2#0100011#
MAXIMUM             = 2#0100011#
DESCRIPTION         = "This field identifies in part the
                      individual application process within the spacecraft that created
                      the Source Packet data.  00100011 is the bit pattern for MOLA."
END_OBJECT          = BIT_COLUMN
END_OBJECT          = COLUMN

...

OBJECT              = COLUMN
NAME                = COMMAND_ECHO
DATA_TYPE          = INTEGER
START_BYTE         = 125
BYTES              = 16
ITEMS              = 8

```

```

ITEM_BYTES           = 2
MINIMUM              = 0
MAXIMUM              = 65535
DESCRIPTION          = "First 8 command words received during
                        current packet, only complete commands are stored, MOLA specific
                        commands only. The software attempts to echo all valid commands.
                        If the command will fit in the room remaining in the..."
END_OBJECT           = COLUMN

OBJECT               = COLUMN
NAME                 = PACKET_VALIDITY_CHECKSUM
DATA TYPE            = INTEGER
START_BYTE           = 141
BYTES                = 2
MINIMUM              = 0
MAXIMUM              = 65535
DESCRIPTION          = "Simple 16 bit addition of entire packet
                        contents upon completion. This location is zeroed for addition.
                        This word is zeroed, then words 0-539 are added without carry to a
                        variable that is initially zero. The resulting lower 16 bits
                        are..."
END_OBJECT           = COLUMN

OBJECT               = CONTAINER
NAME                 = FRAME_STRUCTURE
^STRUCTURE           = "MOLASCFR.FMT" /*points to the columns*/
                        /*that make up the frame descriptors */
START_BYTE           = 143
BYTES                = 134
REPETITIONS          = 7
DESCRIPTION          = "The frame_structure container
                        represents the format of seven repeating groups of attributes in
                        this data product. The data product reflects science data
                        acquisition from seven different frames. Since the data from each
                        frame are ..."
END_OBJECT           = CONTAINER

```

#### Contents of the MOLASCFR.FMT FILE:

```

OBJECT               = CONTAINER
NAME                 = COUNTS
START_BYTE           = 1
BYTES                = 4
REPETITIONS          = 20
^STRUCTURE           = "MOLASCCT.FMT"
DESCRIPTION          = "This container has three sub-elements
                        (range to surface counts, 1st channel received pulse energy, and
                        2nd channel received pulse energy). The three sub-elements repeat
                        for each of 20 shots."
END_OBJECT           = CONTAINER

OBJECT               = COLUMN
NAME                 = SHOT_2_LASER_TRANSMITTER_POWR

```



```

DATA_TYPE          = UNSIGNED_INTEGER
START_BYTE        = 81
BYTES             = 1
MINIMUM           = 0
MAXIMUM           = 65535
DESCRIPTION       = "... "
END_OBJECT        = COLUMN

OBJECT            = COLUMN
NAME              = SHOT_1_LASER_TRANSMITTER_POWR
DATA_TYPE        = UNSIGNED_INTEGER
START_BYTE      = 82
BYTES           = 1
MINIMUM        = 0
MAXIMUM        = 65535
DESCRIPTION    = "... "
END_OBJECT     = COLUMN

OBJECT            = COLUMN
NAME              = SHOT_4_LASER_TRANSMITTER_POWR
DATA_TYPE        = UNSIGNED_INTEGER
START_BYTE      = 83
BYTES           = 1
MINIMUM        = 0
MAXIMUM        = 65535
DESCRIPTION    = "... "
END_OBJECT     = COLUMN

...

OBJECT            = COLUMN
NAME              = CH_3_2ND_HALF_FRAME_BKGRND_CN
DATA_TYPE        = UNSIGNED_INTEGER
START_BYTE      = 133
BYTES           = 1
MINIMUM        = 0
MAXIMUM        = 255
DESCRIPTION    = "The background energy or noise count
                  levels in channels 1, 2, 3, and 4 respectively by half-frame.
                  Pseudo log value of NOISE(1, 2, 3, 4) at the end of a half-frame
                  of current frame, 5.3 bit format. Plog base 2 of background count
                  sum..."
END_OBJECT     = COLUMN

OBJECT            = COLUMN
NAME              = CH_4_2ND_HALF_FRAME_BKGRND_CN
DATA_TYPE        = UNSIGNED_INTEGER
START_BYTE      = 134
BYTES           = 1
MINIMUM        = 0
MAXIMUM        = 255
DESCRIPTION    = "The background energy or noise count
                  levels in channels 1, 2, 3, and 4 respectively by half-frame.
                  Pseudo log value of NOISE(1, 2, 3, 4) at the end of a half-frame

```

of current frame, 5.3 bit format. Plog base 2 of background count sum..."

END\_OBJECT = COLUMN

#### Contents of the MOLASCCT.FMT FILE:

OBJECT = COLUMN  
 NAME = RANGE\_TO\_SURFACE\_TIU\_CNTRS  
 DATA\_TYPE = MSB\_INTEGER  
 START\_BYTE = 1  
 BYTES = 2  
 DESCRIPTION = "The possible 20 valid frame laser shots surface ranging measurements in Timing Interval Unit (TIU) counts. The least significant 16 bits of TIU (SLTIU), stored for every shot. B[0] = Bits 15-8 of TIU reading; B[1] = Bits 7-0 of ..."  
 END\_OBJECT = COLUMN

OBJECT = COLUMN  
 NAME = FIRST\_CH\_RCVD\_PULSE\_ENRGY  
 DATA\_TYPE = UNSIGNED\_INTEGER  
 START\_BYTE = 3  
 BYTES = 1  
 DESCRIPTION = "The level of return, reflected energy as received by the first channel and matched filter to trigger. This is a set of values for all possible 20 shots within the frame. Lowest numbered non-zero energy reading for each shot."  
 END\_OBJECT = COLUMN

OBJECT = COLUMN  
 NAME = SECOND\_CH\_RCVD\_PULSE\_ENRGY  
 DATA\_TYPE = UNSIGNED\_INTEGER  
 START\_BYTE = 4  
 BYTES = 1  
 DESCRIPTION = "The level of return, reflected energy as received by the second channel and matched filter to trigger. This is a set of values for all possible 20 shots within the frame. 2nd lowest numbered non-zero energy reading for each shot..."  
 END\_OBJECT = COLUMN

## A.9 DATA\_PRODUCER

The DATA\_PRODUCER object is a required sub-object of the VOLUME object. The DATA\_PRODUCER, as opposed to the DATA\_SUPPLIER, is an individual or organization responsible for collecting, assembling, and/or engineering the raw data into one or more data sets.

### A.9.1 Required Keywords

1. INSTITUTION\_NAME
2. FACILITY\_NAME
3. FULL\_NAME
4. ADDRESS\_TEXT

### A.9.2 Optional Keywords

1. DISCIPLINE\_NAME
2. NODE\_NAME
3. TELEPHONE\_NUMBER
4. ELECTRONIC\_MAIL\_TYPE
5. ELECTRONIC\_MAIL\_ID

### A.9.3 Required Objects

None

### A.9.4 Optional Objects

None

### A.9.5 Example

The fragment below was extracted from the example under the VOLUME object.

```

OBJECT                = DATA_PRODUCER
  INSTITUTION_NAME    = "U.S.G.S. FLAGSTAFF"
  FACILITY_NAME       = "BRANCH OF ASTROGEOLOGY"
  FULL_NAME           = "ERIC M. ELIASON"
  DISCIPLINE_NAME     = "IMAGE PROCESSING"
  ADDRESS_TEXT        = "Branch of Astrogeology
                        United States Geological Survey
                        2255 North Gemini Drive

```

```
END_OBJECT          Flagstaff, Arizona 86001 USA"  
                    = DATA_PRODUCER
```

## A.10 DATA\_SUPPLIER

The DATA\_SUPPLIER object is an optional sub-object of the VOLUME object. The DATA\_SUPPLIER, as opposed to the DATA\_PRODUCER, is an individual or organization responsible for distributing the data sets and associated data to the science community.

### A.10.1 Required Keywords

1. INSTITUTION\_NAME
2. FACILITY\_NAME
3. FULL\_NAME
4. ADDRESS\_TEXT
5. TELEPHONE\_NUMBER
6. ELECTRONIC\_MAIL\_TYPE
7. ELECTRONIC\_MAIL\_ID

### A.10.2 Optional Keywords

1. DISCIPLINE\_NAME
2. NODE\_NAME

### A.10.3 Required Objects

None

### A.10.4 Optional Objects

None

### A.10.5 Example

The fragment below was extracted from the larger example which can be found under the VOLUME object.

```

OBJECT                                = DATA_SUPPLIER
  INSTITUTION_NAME                     = "NATIONAL SPACE SCIENCE DATA CENTER"
  FACILITY_NAME                         = "NATIONAL SPACE SCIENCE DATA CENTER"
  FULL_NAME                             = "NATIONAL SPACE SCIENCE DATA CENTER"
  DISCIPLINE_NAME                       = "NATIONAL SPACE SCIENCE DATA CENTER"
  ADDRESS_TEXT                           = "Code 633
                                         Goddard Space Flight Center
                                         Greenbelt, Maryland, 20771, USA"
  TELEPHONE_NUMBER                      = "3012866695"
  ELECTRONIC_MAIL_TYPE                   = "NSI/DECNET"

```

```
ELECTRONIC_MAIL_ID      = "NSSDCA::REQUEST"  
END_OBJECT               = DATA_SUPPLIER
```

## **A.11 DIRECTORY**

The DIRECTORY object is used to define a hierarchical file organization on a linear (i.e., sequential) medium such as tape. The DIRECTORY object identifies all directories and subdirectories below the root level. It is a required sub-object of the VOLUME object for volumes delivered on sequential media.

Note: The root directory on a volume does not need to be explicitly defined with the DIRECTORY object.

Subdirectories are identified by defining DIRECTORY objects as sub-objects of the root DIRECTORY. Files within the directories and subdirectories are sequentially identified by using FILE objects with a SEQUENCE\_NUMBER value corresponding to their position on the medium. The SEQUENCE\_NUMBER value must be unique for each file on the medium.

### **A.11.1 Required Keywords**

1. NAME

### **A.11.2 Optional Keywords**

1. RECORD\_TYPE
2. SEQUENCE\_NUMBER

### **A.11.3 Required Objects**

1. FILE

### **A.11.4 Optional Objects**

1. DIRECTORY

### A.11.5 Example

The fragment below was extracted from the larger example which can be found under the VOLUME object.

```
OBJECT          = DIRECTORY
  NAME         = INDEX

OBJECT          = FILE
  FILE_NAME    = "INDXINFO.TXT"
  RECORD_TYPE  = STREAM
  SEQUENCE_NUMBER = 5
  END_OBJECT   = FILE

OBJECT          = FILE
  FILE_NAME    = "INDEX.LBL"
  RECORD_TYPE  = STREAM
  SEQUENCE_NUMBER = 6
  END_OBJECT   = FILE

OBJECT          = FILE
  FILE_NAME    = "INDEX.TAB"
  RECORD_TYPE  = FIXED_LENGTH
  RECORD_BYTES = 512
  FILE_RECORDS = 6822
  SEQUENCE_NUMBER = 7
  END_OBJECT   = FILE
END_OBJECT     = DIRECTORY
```



## A.12 DOCUMENT

*Note: This section is currently undergoing major revision. Please consult a PDS data engineer for the latest available information on document labelling.*

The DOCUMENT object is used to label a particular document that is provided on a volume to support an archived data product. A document can be made up of one or more files in a single format. For instance, a document may be comprised of as many TIFF files as there are pages in the document.

Multiple versions of a document can be supplied on a volume with separate formats, requiring a DOCUMENT object for each document version (i.e., OBJECT = TEX\_DOCUMENT and OBJECT = PS\_DOCUMENT when including both the TEX and Postscript versions of the same document).

PDS requires that at least one version of any document be plain ASCII text in order to allow users the capability to read, browse, or search the text without requiring software or text processing packages. This version can be plain, unmarked text, or ASCII text containing a markup language. (See the *Documentation* chapter of this document for more details.)

The DOCUMENT object contains keywords that identify and describe the document, provide the date of publication of the document, indicate the number of files comprising the document, provide the format of the document files, and identify the software used to compress or encode the document, as applicable.

DOCUMENT labels must be detached files unless the files are plain, unmarked text that will not be read by text or word processing packages. A DOCUMENT object for each format type of a document can be included in the same label file with pointers, such as ^TIFF\_DOCUMENT for a TIFF formatted document. (See example below.)

### A.12.1 Required Keywords

1. DOCUMENT\_NAME
2. DOCUMENT\_TOPIC\_TYPE
3. INTERCHANGE\_FORMAT
4. DOCUMENT\_FORMAT
5. PUBLICATION\_DATE

### A.12.2 Optional Keywords

1. ABSTRACT\_TEXT
2. DESCRIPTION
3. ENCODING\_TYPE

## 4. FILES

### A.12.3 Required Objects

None

### A.12.4 Optional Objects

None

### A.12.5 Example

The following example detached label, PDSUG.LBL, is for a Document provided in three formats: ASCII text, TIFF, and TEX.

```

PDS_VERSION_ID          = PDS3
RECORD_TYPE             = UNDEFINED

^ASCII_DOCUMENT         = "PDSUG.ASC"
^TIFF_DOCUMENT          = { "PDSUG001.TIF", "PDSUG002.TIF",
                           "PDSUG003.TIF", "PDSUG004.TIF" }
^TEX_DOCUMENT           = "PDSUG.TEX"

OBJECT                  = ASCII_DOCUMENT
  DOCUMENT_NAME         = "Planetary Data System Data Set Catalog
                          User's Guide"
  PUBLICATION_DATE      = 1992-04-13
  DOCUMENT_TOPIC_TYPE   = "USER'S GUIDE"
  INTERCHANGE_FORMAT    = ASCII
  DOCUMENT_FORMAT       = TEXT

DESCRIPTION              = "The Planetary Data System Data Set
                          Catalog User's Guide describes the fundamentals of accessing,
                          searching, browsing, and ordering data from the PDS Data Set Catalog
                          at the Central Node.  The text for this 4-page document is provided
                          here in this plain, ASCII text file."
ABSTRACT_TEXT           = "The PDS Data Set Catalog is similar in
                          function and purpose to a card catalog in a library.  Use a Search
                          screen to find data items, a List/Order screen to order data items,
                          and the More menu option to see more information."
END_OBJECT              = ASCII_DOCUMENT

OBJECT                  = TIFF_DOCUMENT
  DOCUMENT_NAME         = "Planetary Data System Data Set Catalog
                          User's Guide"
  DOCUMENT_TOPIC_TYPE   = "USER'S GUIDE"

```

```

INTERCHANGE_FORMAT      = BINARY
DOCUMENT_FORMAT         = TIFF
PUBLICATION_DATE        = 1992-04-13
FILES                   = 4
ENCODING_TYPE           = "CCITT/3"
DESCRIPTION              = "The Planetary Data System Data Set
  Catalog User's Guide describes the fundamentals of accessing,
  searching, browsing, and ordering data from the PDS Data Set Catalog
  at the Central Node.

  The 4-page document is provided here in 4 consecutive files, one
  file per page, in Tagged Image File Format (TIFF) using Group 3
  compression.  It has been successfully imported into WordPerfect
  5.0, FrameMaker, and Photoshop."
ABSTRACT_TEXT           = "The PDS Data Set Catalog is similar in
  function and purpose to a card catalog in a library.  Use a Search
  screen to find data items, a List/Order screen to order data items,
  and the More menu option to see more information."
END_OBJECT               = TIFF_DOCUMENT

OBJECT                  = TEX_DOCUMENT
DOCUMENT_NAME            = "Planetary Data System Data Set Catalog
  User's Guide"
DOCUMENT_TOPIC_TYPE      = "USER'S GUIDE"
INTERCHANGE_FORMAT       = ASCII
DOCUMENT_FORMAT          = TEX
PUBLICATION_DATE         = 1992-04-13
DESCRIPTION              = "The Planetary Data System Data Set
  Catalog User's Guide describes the fundamentals of accessing,
  searching, browsing, and ordering data from the PDS Data Set Catalog
  at the Central Node.

  The 4-page document is provided here in TeX format with all
  necessary macros included."
ABSTRACT_TEXT           = "The PDS Data Set Catalog is similar in
  function and purpose to a card catalog in a library.  Use a Search
  screen to find data items, a List/Order screen to order data items,
  and the More menu option to see more information."
END_OBJECT               = TEX_DOCUMENT
END

```

## A.13 ELEMENT (Primitive Data Object)

The ELEMENT object provides a means of defining a lowest-level component of a data object, and which can be stored in an integral multiple of 8-bit bytes. ELEMENT objects may be embedded in COLLECTION and ARRAY data objects. The optional START\_BYTE element identifies a location relative to the enclosing object. If not explicitly included, a START\_BYTE = 1 is assumed for the ELEMENT.

### A.13.1 Required Keywords

1. BYTES
2. DATA\_TYPE
3. NAME

### A.13.2 Optional Keywords

1. START\_BYTE
2. BIT\_MASK
3. DERIVED\_MAXIMUM
4. DERIVED\_MINIMUM
5. DESCRIPTION
6. FORMAT
7. INVALID\_CONSTANT
8. MINIMUM
9. MAXIMUM
10. MISSING\_CONSTANT
11. OFFSET
12. SCALING\_FACTOR
13. UNIT
14. VALID\_MINIMUM
15. VALID\_MAXIMUM

### A.13.3 Required Objects

None

### A.13.4 Optional Objects

None

### **A.13.5 Example**

Please refer to the example in the ARRAY Primitive object (Section A.2) for an example of the use of the ELEMENT object.

## A.14 FIELD

The FIELD object identifies a single variable-width field in a SPREADSHEET object.

Notes:

1. The only PDS data object that includes FIELD objects is the SPREADSHEET. FIELDS must not themselves contain embedded FIELD objects.
2. The DATA\_TYPE keyword is required to specify the data type of the values that are stored in the field when data are present.
3. A vector with two or more identically formatted components may be specified as a single FIELD by using the ITEM and ITEM\_BYTES elements. The ITEMS data element indicates the number of occurrences within the field (i.e., components in the vector).
4. If a FIELD contains multiple items, then the ITEM\_BYTES keyword is used to specify the maximum number of bytes any item in the set may have. ITEM\_BYTES does not include the quotation marks that enclose string items.
5. The BYTES keyword is used to specify the maximum size of the FIELD object, not including leading or trailing delimiters or line terminators. When a field contains items, the BYTES value is set to the product of the ITEM\_BYTES and ITEMS values plus the number of interior delimiter bytes (e.g., for three ASCII\_INTEGER items of three bytes each ITEMS = 3, ITEM\_BYTES=3, and BYTES= 11, which includes the two delimiters WITHIN the field but not the trailing delimiter).
6. The (optional) FORMAT element may be used to specify the format of FIELD data when they are present. The FORMAT specification applies to the maximum size of the field object, allowing shorter variations. For example, FORMAT = "F5.1" is consistent with each of the following:
  - ... ,127.1, ...
  - ... ,-12.7, ...
  - ... ,3.1, ...
  - ... ,3.01, ... and
  - ... ,, ...
7. Inclusion of data elements VALID\_MINIMUM and VALID\_MAXIMUM within FIELD object definitions is encouraged.
8. If data element MISSING\_CONSTANT is used, its meaning must be clearly stated since absence of a field value is the default indication of 'no data'.

### A.14.1 Required Keywords

1. BYTES
2. DATA\_TYPE
3. NAME

### A.14.2 Optional Keywords

1. DESCRIPTION
2. FIELD\_NUMBER
3. FORMAT
4. ITEM\_BYTES
5. ITEMS
6. UNIT
7. VALID\_MAXIMUM
8. VALID\_MINIMUM
9. PSDD

### A.14.3 Required Objects

None

### A.14.4 Optional Objects

1. ALIAS

### A.14.5 Example 1

The label fragment below shows a simple FIELD object from a SPREADSHEET object (see the SPREADSHEET section of this document).

```

OBJECT                = FIELD
  NAME                = "DETECTOR TEMPERATURE"
  FIELD_NUMBER        = 3
  BYTES               = 5
  DATA_TYPE          = "ASCII_REAL"
  FORMAT              = "F5.1"
  UNIT                = "KELVIN"
END_OBJECT            = FIELD

```

### A.14.6 Example 2

The fragment below shows two FIELDS containing multiple items. The first FIELD is a vector containing three ASCII\_INTEGER items: xx, yy, zz. The second FIELD contains three character items: "xx", "yy" and "zz". Note that the value of BYTES includes the comma delimiters between items, but the ITEM\_BYTES value does not.

```

OBJECT          = FIELD
  NAME          = "FIELD 1 - IX, IY, IZ"
  DATA_TYPE    = "ASCII_INTEGER"
  FIELD_NUMBER  = 1
  BYTES         = 8      /*includes item separating delimiters*/
  ITEMS        = 3      /* i.e. 17,15,27   or   1,2,3   */
  ITEM_BYTES    = 2      /* individual item maximum size in bytes */
  FORMAT       = "I2"
  MISSING_CONSTANT = -1
  DESCRIPTION   = "Raw values of FIELD 1.  IX, IY, and IZ represent
                  independent, non-negative measurements.  A value
                  of -1 denotes a measurement that could not be
                  processed."
END_OBJECT      = FIELD

OBJECT          = FIELD
  NAME          = "FIELD 2 - AX, AY,AZ"
  DATA_TYPE    = "CHARACTER"
  FIELD_NUMBER  = 2      /* One FIELD object precedes this object
*/
  BYTES         = 12     /* Doesn't include first/last quotes */
  ITEMS        = 3      /* i.e. "xx","yy","zz" */
  ITEM_BYTES    = 2
  FORMAT       = "A2"
END_OBJECT      = FIELD

```



## A.15 FILE

The FILE object is used in attached or detached labels to define the attributes or characteristics of a data file. In attached labels, the file object is also used to indicate boundaries between label records and data records in data files which have attached labels. The FILE object may be used in three ways:

1. As an implicit object in attached or detached labels. All detached label files and attached labels contain an implicit FILE object which starts at the top of the label and ends where the label ends. In these cases, the PDS recommends against using the NAME keyword to reference the file name. This label fragment shows the required FILE object elements as they typically appear in labels:

```
RECORD_TYPE      = FIXED_LENGTH
RECORD_BYTES     = 80
FILE_RECORDS     = 522
LABEL_RECORDS   = 10
```

For data products labelled using the implicit file object (e.g., in minimal labels) "DATA\_OBJECT\_TYPE = FILE" should be used in the DATA\_SET catalog object.

2. As an explicit object which is used when a file reference is needed in a combined detached or minimal label. In this case, the optional FILE\_NAME element is used to identify the file being referenced.

```
OBJECT           = FILE
FILE_NAME        = "IM10347.DAT"
RECORD_TYPE     = STREAM
FILE_RECORDS    = 1024
. . .
END_OBJECT      = FILE
```

For data products labelled using the explicit FILE object (e.g., in minimal labels) DATA\_OBJECT\_TYPE = FILE should be used in the DATA\_SET catalog object.

3. As an explicit object to identify specific files as sub-objects of the DIRECTORY in VOLUME objects. In this case, the optional FILE\_NAME element is used to identify the file being referenced on a tape archive volume.

```
OBJECT           = FILE
FILE_NAME        = "VOLDESC.CAT"
RECORD_TYPE     = STREAM
SEQUENCE_NUMBER = 1
END_OBJECT      = FILE
```

The keywords in the FILE object always describe the file being referenced, and not the file in which the keywords are contained (i.e., if the FILE object is used in a detached label file, the FILE object keywords describe the detached data file, not the label file which contains the keywords). For example, if a detached label for a data file is being created and the label will be in STREAM format, but the data will be stored in a file having FIXED\_LENGTH records, then the RECORD\_TYPE keyword in the label file must be given the value FIXED\_LENGTH.

The following table identifies data elements that are required (Req), optional (Opt), and not applicable (-) for various types of files

Labeling Method	Att Det		Att Det		Att Det		Att Det	
RECORD_TYPE	FIXED_LENGTH		VARIABLE_LENGTH		STREAM		UNDEFINED	
RECORD_BYTES	Req	Req	Rmax	Rmax	Omax	-	-	-
FILE_RECORDS	Req	Req	Req	Req	Opt	Opt	-	-
LABEL_RECORDS	Req	-	Req	-	Opt	-	-	-

### A.15.1 Required Keywords

#### 1. RECORD\_TYPE

(See above table for the conditions of use of additional required keywords)

### A.15.2 Optional Keywords

1. DESCRIPTION
2. ENCODING\_TYPE
3. FILE\_NAME (required only in minimal detached labels and tape archives)
4. FILE\_RECORDS (required only in minimal detached labels and tape archives)
5. INTERCHANGE\_FORMAT
6. LABEL\_RECORDS
7. RECORD\_BYTES
8. REQUIRED\_STORAGE\_BYTES
9. SEQUENCE\_NUMBER
10. UNCOMPRESSED\_FILE\_NAME

### A.15.3 Required Objects

None

### A.15.4 Optional Objects

None

### A.15.5 Example

Following is an example of a set of explicit FILE objects in a combined detached label. An additional example of the use of explicit FILE object can be found under the VOLUME object (Section A.29).

```

PDS_VERSION_ID          = PDS3
HARDWARE_MODEL_ID      = "SUN SPARC STATION"
OPERATING_SYSTEM_ID    = "SUN OS 4.1.1"
SPACECRAFT_NAME        = "VOYAGER 2"
INSTRUMENT_NAME        = "PLASMA WAVE RECEIVER"
MISSION_PHASE_NAME     = "URANUS ENCOUNTER"
TARGET_NAME            = URANUS
DATA_SET_ID            = "VG2-U-PWS-4-RDR-SA-48.0SEC-V1.0"
PRODUCT_ID             = "T860123-T860125"

OBJECT                  = FILE
  FILE_NAME             = "T860123.DAT"
  FILE_RECORDS          = 1800
  RECORD_TYPE           = FIXED_LENGTH
  RECORD_BYTES          = 105
  START_TIME            = 1986-01-23T00:00:00.000
  STOP_TIME             = 1986-01-24T00:00:00.000
  ^TIME_SERIES         = "T860123.DAT"

OBJECT                  = TIME_SERIES
  INTERCHANGE_FORMAT    = BINARY
  ROWS                  = 1800
  ROW_BYTES             = 105
  COLUMNS              = 19
  ^STRUCTURE            = "PWS_DATA.FMT"
  SAMPLING_PARAMETER_NAME = TIME
  SAMPLING_PARAMETER_UNIT = SECOND
  SAMPLING_PARAMETER_INTERVAL = 48.0
  END_OBJECT            = TIME_SERIES
END_OBJECT              = FILE

OBJECT                  = FILE
  FILE_NAME             = "T860124.DAT"
  FILE_RECORDS          = 1800
  RECORD_TYPE           = FIXED_LENGTH
  RECORD_BYTES          = 105
  START_TIME            = 1986-01-24T00:00:00.000
  STOP_TIME             = 1986-01-25T00:00:00.000
  ^TIME_SERIES         = "T860124.DAT"

```

```

OBJECT                = TIME_SERIES
  INTERCHANGE_FORMAT  = BINARY
  ROWS                 = 1800
  ROW_BYTES            = 105
  COLUMNS             = 19
  ^STRUCTURE           = "PWS_DATA.FMT"
  SAMPLING_PARAMETER_NAME = TIME
  SAMPLING_PARAMETER_UNIT = SECOND
  SAMPLING_PARAMETER_INTERVAL = 48.0
END_OBJECT            = TIME_SERIES
END_OBJECT            = FILE

OBJECT                = FILE
  FILE_NAME            = "T860125.DAT"
  FILE_RECORDS         = 1799
  RECORD_TYPE          = FIXED_LENGTH
  RECORD_BYTES         = 105
  START_TIME           = 1986-01-30T00:00:00.000
  STOP_TIME            = 1986-01-30T23:59:12.000
  ^TIME_SERIES         = "T860125.DAT"

OBJECT                = TIME_SERIES
  INTERCHANGE_FORMAT  = BINARY
  ROWS                 = 1799
  ROW_BYTES            = 105
  COLUMNS             = 19
  ^STRUCTURE           = "PWS_DATA.FMT"
  SAMPLING_PARAMETER_NAME = TIME
  SAMPLING_PARAMETER_UNIT = SECOND
  SAMPLING_PARAMETER_INTERVAL = 48.0
END_OBJECT            = TIME_SERIES
END_OBJECT            = FILE
END

```

## A.16 GAZETTEER\_TABLE

The GAZETTEER\_TABLE object is a specific type of TABLE object that provides information about the geographical features of a planet or satellite. It contains information about named features such as location, size, origin of feature name, and so on. The GAZETTEER\_TABLE contains one row for each named feature on the target body. The table is formatted so that it may be read directly by many data management systems on various host computers. All fields (columns) are separated by commas, and character fields are enclosed by double quotation marks. Each record consist of 480 bytes, with a carriage return/line feed sequence in bytes 479 and 480. This allows the table to be treated as a fixed length record file on hosts that support this file type and as a normal text file on other hosts.

Currently the PDS Imaging Node at the USGS is the data producer for all GAZETTEER\_TABLEs.

### A.16.1 Required Keywords

1. NAME
2. INTERCHANGE\_FORMAT
3. ROWS
4. COLUMNS
5. ROW\_BYTES
6. DESCRIPTION

### A.16.2 Optional Keywords

Any

### A.16.3 Required Objects

1. COLUMN

#### A.16.3.1 Required COLUMN Objects (NAME =)

TARGET\_NAME  
SEARCH\_FEATURE\_NAME  
DIACRITIC\_FEATURE\_NAME  
MINIMUM\_LATITUDE  
MAXIMUM\_LATITUDE  
CENTER\_LATITUDE  
MINIMUM\_LONGITUDE

MAXIMUM\_LONGITUDE  
 CENTER\_LONGITUDE  
 LABEL\_POSITION\_ID  
 FEATURE\_LENGTH  
 PRIMARY\_PARENTAGE\_ID  
 SECONDARY\_PARENTAGE\_ID  
 MAP\_SERIAL\_ID  
 FEATURE\_STATUS\_TYPE  
 APPROVAL\_DATE  
 FEATURE\_TYPE  
 REFERENCE\_NUMBER  
 MAP\_CHART\_ID  
 FEATURE\_DESCRIPTION

### A.16.3.2 Required Keywords (for Required COLUMN Objects)

NAME  
 DATA\_TYPE  
 START\_BYTE  
 BYTES  
 FORMAT  
 UNIT  
 DESCRIPTION

### A.16.4 Optional Objects

None

### A.16.5 Example

```

PDS_VERSION_ID           = PDS3
RECORD_TYPE              = FIXED_LENGTH
RECORD_BYTES             = 480
FILE_RECORDS             = 1181
PRODUCT_ID               = XYZ
TARGET_NAME              = MARS
^GAZETTEER_TABLE        = "GAZETTER.TAB"

OBJECT                   = GAZETTEER_TABLE
  NAME                   = "PLANETARY NOMENCLATURE GAZETTEER"
  INTERCHANGE_FORMAT     = ASCII
  ROWS                   = 1181
  COLUMNS               = 20
  ROW_BYTES              = 480
  DESCRIPTION            = "The gazetteer (file: GAZETTER.TAB) is a
    table of geographical features for a planet or satellite.  It
  
```

contains information about a named feature such as location, size, origin of feature name, etc. The Gazetteer Table contains one row for each feature named on the target body. The table is formatted so that it may be read directly into many data management systems on various host computers. All fields (columns) are separated by commas, and character fields are preceded by double quotation marks. Each record consist of 480 bytes, with a carriage return/line feed sequence in bytes 479 and 480. This allows the table to be treated as a fixed length record file on hosts that support this file type and as a normal text file on other hosts."

```

OBJECT                = COLUMN
  NAME                = TARGET_NAME
  DATA_TYPE          = CHARACTER
  START_BYTE          = 2
  BYTES                = 20
  FORMAT              = "A20"
  UNIT                = "N/A"
  DESCRIPTION          = "The planet or satellite on which the
                        feature is located."
END_OBJECT            = COLUMN

```

```

OBJECT                = COLUMN
  NAME                = SEARCH_FEATURE_NAME
  DATA_TYPE          = CHARACTER
  START_BYTE          = 25
  BYTES                = 50
  FORMAT              = "A50"
  UNIT                = "N/A"
  DESCRIPTION          = "The geographical feature name with all
                        diacritical marks stripped off. This name is stored in upper case
                        only so that it can be used for sorting and search purposes. This
                        field should not be used to designate the name of the feature
                        because it does not contain the diacritical marks. Feature names not
                        containing diacritical marks can often take on a completely
                        different meaning and in some cases the meaning can be deeply
                        offensive."
END_OBJECT            = COLUMN

```

```

OBJECT                = COLUMN
  NAME                = DIACRITIC_FEATURE_NAME
  DATA_TYPE          = CHARACTER
  START_BYTE          = 78
  BYTES                = 100
  FORMAT              = "A100"
  UNIT                = "N/A"
  DESCRIPTION          = "The geographical feature name
                        containing standard diacritical information. A detailed description
                        of the diacritical mark formats are described in the gazetteer
                        documentation."

```

DIACRITICALS USED IN THE TABLE

The word *diacritic* comes from a Greek word meaning to separate. It refers to the accent marks employed to separate, or distinguish, one form of pronunciation of a vowel or consonant from another.

This note is included to familiarize the user with the codes used to represent diacriticals found in the table, and the values usually associated with them. In the table, the code for a diacritical is preceded by a backslash and is followed, without a space, by the letter it is modifying.

This note is organized as follows: the code is listed first, followed by the name of the accent mark, if applicable, a brief description of the appearance of the diacritical and a short narrative on its usage.

*acute accent*; a straight diagonal line extending from upper right to lower left. The acute accent is used in most languages to lengthen a vowel; in some, such as Oscan, to denote an open vowel. The acute is also often used to indicate the stressed syllable; in some transcriptions it indicates a palatalized consonant.

*diaeresis or umlaut*; two dots surmounting the letter. In Romance languages and English, the diaeresis is used to indicate that consecutive vowels do not form a diphthong (see below); in modern German and Scandinavian languages, it denotes palatalization of vowels.

*circumflex*; a chevron or inverted 'v' shape, with the apex at the top. Used most often in modern languages to indicate lengthening of a vowel.

*tilde*; a curving or waving line above the letter. The tilde is a form of circumflex. The tilde is used most often in Spanish to form a palatalized n as in the word 'ano', pronounced 'anyo'. It is also used occasionally to indicate nasalized vowels.

*macron*; a straight line above the letter. The macron is used almost universally to lengthen a vowel.

*breve*; a concave semicircle or 'u' shape surmounting the letter. Originally used in Greek, the breve indicates a short vowel.

a small circle or 'o' above the letter. Frequently used in Scandinavian languages to indicate a broad 'o'.

*e diphthong or ligature*; transcribed as two letters in contact with each other. The diphthong is a combination of vowels that are pronounced together.

*cedilla*; a curved line surmounted by a vertical line, placed at the bottom of the letter. The cedilla is used in Spanish and French to denote a dental, or soft, 'c'. In the new Turkish transcription, 'c' cedilla has the value of English 'ch'. In Semitic languages, the cedilla under a consonant indicates that it is emphatic.



check or inverted circumflex; a 'v' shape above the letter. This accent is used widely in Slavic languages to indicate a palatal articulation, like the consonant sounds in the English words chapter and shoe and the 'zh' sound in pleasure.

a single dot above the letter. This diacritical denotes various things; in Lithuanian, it indicates a close long vowel. In Sanskrit, when used with 'n', it is a velar sound, as in the English 'sink'; in Irish orthography, it indicates a fricative consonant (see below).

accent grave; a diagonal line (above the letter) extending from upper left to lower right. The grave accent is used in French, Spanish and Italian to denote open vowels.

fricative; a horizontal line through a consonant. A fricative consonant is characterized by a frictional rustling of the breath as it is emitted."

```

END_OBJECT                = COLUMN

OBJECT                    = COLUMN
  NAME                    = MINIMUM_LATITUDE
  DATA_TYPE              = REAL
  START_BYTE              = 180
  BYTES                   = 7
  FORMAT                  = "F7.2"
  UNIT                    = DEGREE
  DESCRIPTION             = "The minimum_latitude element specifies
the southernmost latitude of a spatial area, such as a map, mosaic,
bin, feature, or region."
END_OBJECT                = COLUMN

OBJECT                    = COLUMN
  NAME                    = MAXIMUM_LATITUDE
  DATA_TYPE              = REAL
  START_BYTE              = 188
  BYTES                   = 7
  FORMAT                  = "F7.2"
  UNIT                    = DEGREE
  DESCRIPTION             = "The maximum_latitude element specifies
the northernmost latitude of a spatial area, such as a map, mosaic,
bin, feature, or region."
END_OBJECT                = COLUMN

OBJECT                    = COLUMN
  NAME                    = CENTER_LATITUDE
  DATA_TYPE              = REAL
  START_BYTE              = 196
  BYTES                   = 7
  FORMAT                  = "F7.2"
  UNIT                    = DEGREE
  DESCRIPTION             = "The center latitude of the feature."

```

```

END_OBJECT                = COLUMN

OBJECT                    = COLUMN
  NAME                    = MINIMUM_LONGITUDE
  DATA_TYPE              = REAL
  START_BYTE              = 204
  BYTES                   = 7
  FORMAT                  = "F7.2"
  UNIT                    = DEGREE
  DESCRIPTION             = "The minimum_longitude element
specifies the easternmost latitude of a spatial area, such as a
map, mosaic, bin, feature, or region.  "
END_OBJECT                = COLUMN

OBJECT                    = COLUMN
  NAME                    = MAXIMUM_LONGITUDE
  DATA_TYPE              = REAL
  START_BYTE              = 212
  BYTES                   = 7
  FORMAT                  = "F7.2"
  UNIT                    = DEGREE
  DESCRIPTION             = "The maximum_longitude element specifies
the westernmost longitude of a spatial area, such as a map, mosaic,
bin, feature, or region.  "
END_OBJECT                = COLUMN

OBJECT                    = COLUMN
  NAME                    = CENTER_LONGITUDE
  DATA_TYPE              = REAL
  START_BYTE              = 220
  BYTES                   = 7
  FORMAT                  = "F7.2"
  UNIT                    = DEGREE
  DESCRIPTION             = "The center longitude of the feature."
END_OBJECT                = COLUMN

OBJECT                    = COLUMN
  NAME                    = LABEL_POSITION_ID
  DATA_TYPE              = CHARACTER
  START_BYTE              = 229
  BYTES                   = 2
  FORMAT                  = "A2"
  UNIT                    = "N/A"
  DESCRIPTION             = "The suggested plotting position of the
feature name (UL=Upper left, UC=Upper center, UR=Upper right,
CL=Center left, CR=Center right, LL=Lower left, LC=Lower center,
LR=Lower right). This field is used to instruct the plotter where to
place the typographical label with respect to the center of the
feature. This code is used to avoid crowding of names in areas
where there is a high density of named features."
END_OBJECT                = COLUMN

OBJECT                    = COLUMN
  NAME                    = FEATURE_LENGTH

```

```

DATA_TYPE           = REAL
START_BYTE         = 233
BYTES              = 8
FORMAT             = "F8.2"
UNIT               = KILOMETER
DESCRIPTION        = "The longer or longest dimension of an
object. For the Gazetteer usage, this field refers to the length of
the named feature."
END_OBJECT         = COLUMN

OBJECT             = COLUMN
NAME               = PRIMARY_PARENTAGE_ID
DATA_TYPE         = CHARACTER
START_BYTE       = 243
BYTES            = 2
FORMAT          = "A2"
UNIT            = "N/A"
DESCRIPTION     = "This field contains the primary origin
of the feature name (i.e. where the name originated). It contains
a code for the continent or country origin of the name. Please see
Appendix 5 of the gazetteer documentation (GAZETTER.TXT) for a
definition of the codes used to define the continent or country."
END_OBJECT      = COLUMN

OBJECT             = COLUMN
NAME               = SECONDARY_PARENTAGE_ID
DATA_TYPE         = CHARACTER
START_BYTE       = 248
BYTES            = 2
FORMAT          = "A2"
UNIT            = "N/A"
DESCRIPTION     = "This field contains the secondary
origin of the feature name. It contains a code for a country, state,
territory, or ethnic group. Please see Appendix 5 of the gazetteer
documentation (GAZETTER.TXT) for a defintion of the codes in this
field."

END_OBJECT         = COLUMN

OBJECT             = COLUMN
NAME               = MAP_SERIAL_ID
DATA_TYPE         = CHARACTER
START_BYTE       = 253
BYTES            = 6
FORMAT          = "A6"
UNIT            = "N/A"
DESCRIPTION     = "The identification of the map that
contains the named feature. This field represents the map serial
number of the map publication used for ordering maps from the U.S.
Geological Survey. The map identified in this field best portrays
the named feature."
END_OBJECT      = COLUMN

OBJECT             = COLUMN

```

```

NAME = FEATURE_STATUS_TYPE
DATA_TYPE = CHARACTER
START_BYTE = 262
BYTES = 12
FORMAT = "A12"
UNIT = "N/A"
DESCRIPTION = "The IAU approval status of the named
feature. Permitted values are 'PROPOSED', 'PROVISIONAL', 'IAU-
APPROVED', and 'DROPPED'. Dropped names have been disallowed by the
IAU. However, these features have been included in the gazetteer for
historical purposes. Some named features that are disallowed by the
IAU may commonly be used on some maps."
END_OBJECT = COLUMN

OBJECT = COLUMN
NAME = APPROVAL_DATE
DATA_TYPE = INTEGER
START_BYTE = 276
BYTES = 4
FORMAT = "I4"
UNIT = "N/A"
DESCRIPTION = "Date at which an object has been
approved by the officially sanctioned organization. This field
contains the year the IAU approved the feature name."
END_OBJECT = COLUMN

OBJECT = COLUMN
NAME = FEATURE_TYPE
DATA_TYPE = CHARACTER
START_BYTE = 282
BYTES = 20
FORMAT = "A20"
UNIT = "N/A"
DESCRIPTION = "The feature type identifies the type of
a particular feature, according to IAU standards. Examples are
'CRATER', 'TESSERA', 'TERRA', etc. See Appendix 7 of the gazetteer
documentation (GAZETTER.TXT).

DESCRIPTOR TERMS (FEATURE TYPES)

FEATURE DESCRIPTION
ALBEDO FEATURE Albedo feature
CATENA Chain of craters
CAVUS Hollows, irregular depressions
CHAOS Distinctive area of broken terrain
CHASMA Canyon
COLLES Small hill or knob
CORONA Ovoid-shaped feature
CRATER Crater
DORSUM Ridge
ERUPTIVE CENTER Eruptive center
FACULA Bright spot
FLEXUS Cuspate linear feature
FLUCTUS Flow terrain

```

FOSSA	Long, narrow, shallow depression
LABES	Landslide
LABYRINTHUS	Intersecting valley complex
LACUS	Lake
LARGE RINGED FEATURE	Large ringed feature
LINEA	Elongate marking
MACULA	Dark spot
MARE	Sea
MENSA	Mesa, flat-topped elevation
MONS	Mountain
OCEANUS	Ocean
PALUS	Swamp
PATERA	Shallow crater; scalloped, complex edge
PLANITIA	Low plain
PLANUM	Plateau or high plain
PROMONTORIUM	Cape
REGIO	Region
RIMA	Fissure
RUPES	Scarp
SCOPULUS	Lobate or irregular scarp
SINUS	Bay
SULCUS	Subparallel furrows and ridges
TERRA	Extensive land mass
TESSERA	Tile; polygonal ground
THOLUS	Small domical mountain or hill
UNDAE	Dunes
VALLIS	Sinuuous valley
VASTITAS	Widespread lowlands
VARIABLE FEATURE	Variable feature "
END_OBJECT	= COLUMN
OBJECT	= COLUMN
NAME	= REFERENCE_NUMBER
DATA_TYPE	= INTEGER
START_BYTE	= 304
BYTES	= 4
FORMAT	= "I4"
UNIT	= "N/A"
DESCRIPTION	= "Literature reference from which the spelling and description of the feature name was derived. See Appendix 6 of the gazetteer documentation (GAZETTER.TXT)."
END_OBJECT	= COLUMN
OBJECT	= COLUMN
NAME	= MAP_CHART_ID
DATA_TYPE	= CHARACTER
START_BYTE	= 310
BYTES	= 6
FORMAT	= "A6"
UNIT	= "N/A"
DESCRIPTION	= "This field contains the abbreviation of the map designator or chart identification (example MC-19, MC-18, etc.)."
END_OBJECT	= COLUMN

```
OBJECT                = COLUMN
  NAME                = FEATURE_DESCRIPTION
  DATA_TYPE          = CHARACTER
  START_BYTE          = 319
  BYTES               = 159
  FORMAT              = "A159"
  UNIT                = "N/A"
  DESCRIPTION         = "Short description of the feature name."
  END_OBJECT          = COLUMN
END_OBJECT            = GAZETTEER_TABLE
END
```

## A.17 HEADER

The HEADER object is used to identify and define the attributes of commonly used header data structures such as VICAR or FITS. These structures are usually system or software specific and are described in detail in a referenced description text file. The use of BYTES within the header object refers to the number of bytes for the entire header, not a single record.

### A.17.1 Required Keywords

1. BYTES
2. HEADER\_TYPE

### A.17.2 Optional Keywords

1. DESCRIPTION
2. INTERCHANGE\_FORMAT
3. RECORDS

### A.17.3 Required Objects

None

### A.17.4 Optional Objects

None

### A.17.5 Example

The following example shows the detached label file “TIMTC02A.LBL”. The label describes the data product file “TIMTC02A.IMG” which contains a HEADER object followed by an IMAGE object.

```
PDS_VERSION_ID          = PDS3

/* PDS label for a TIMS image */

RECORD_TYPE              = FIXED_LENGTH
RECORD_BYTES             = 638
FILE_RECORDS             = 39277

/* Pointers to objects */
```

```

^IMAGE_HEADER      = ( "TIMTC02A.IMG", 1 )
^IMAGE             = ( "TIMTC02A.IMG", 2 )

/* Image description */

DATA_SET_ID        = "C130-E-TIMS-2-EDR-IMAGE-V1.0"
PRODUCT_ID         = "TIMTC02A"
INSTRUMENT_HOST_NAME = "NASA C-130 AIRCRAFT"
INSTRUMENT_NAME    = "THERMAL INFRARED MULTISPECTRAL SCANNER"
TARGET_NAME        = EARTH
FEATURE_NAME       = "TRAIL CANYON FAN"
START_TIME         = 1989-09-29T21:47:35
STOP_TIME          = 1989-09-29T21:47:35
CENTER_LATITUDE    = 36.38
CENTER_LONGITUDE   = 116.96
INCIDENCE_ANGLE    = 0.0
EMISSION_ANGLE     = 0.0

/* Description of objects */

OBJECT              = IMAGE_HEADER
  BYTES              = 638
  RECORDS            = 1
  HEADER_TYPE        = VICAR2
  INTERCHANGE_FORMAT = BINARY
  ^DESCRIPTION       = "VICAR2.TXT"
END_OBJECT          = IMAGE_HEADER

OBJECT              = IMAGE
  LINES              = 6546
  LINE_SAMPLES       = 638
  SAMPLE_TYPE        = UNSIGNED_INTEGER
  SAMPLE_BITS        = 8
  SAMPLE_BIT_MASK    = 2#11111111#
  BANDS              = 6
  BAND_STORAGE_TYPE  = LINE_INTERLEAVED
END_OBJECT          = IMAGE
END

```



## A.18 HISTOGRAM

The HISTOGRAM object is a sequence of numeric values that provides the number of occurrences of a data value or a range of data values in a data object. The number of items in a histogram will normally be equal to the number of distinct values allowed in a field of the data object. For example, an 8-bit integer field can have a maximum of 256 values, and would result in a 256 item histogram. HISTOGRAMs may be used to bin data, in which case an offset and scaling factor indicate the dynamic range of the data represented.

The following equation allows the calculation of the range of each bin in the histogram:

$$\text{bin\_lower\_boundary} = \text{bin\_element} * \text{SCALING\_FACTOR} + \text{OFFSET}$$

### A.18.1 Required Keywords

1. ITEMS
2. DATA\_TYPE
3. ITEM\_BYTES

### A.18.2 Optional Keywords

1. BYTES
2. INTERCHANGE\_FORMAT
3. OFFSET
4. SCALING\_FACTOR

### A.18.3 Required Objects

None

### A.18.4 Optional Objects

None

### A.18.5 Example

```

PDS_VERSION_ID                = PDS3

/*          FILE FORMAT AND LENGTH */

RECORD_TYPE                    = FIXED_LENGTH
RECORD_BYTES                   = 956
FILE_RECORDS                   = 965
LABEL_RECORDS                  = 3

/*          POINTERS TO START RECORDS OF OBJECTS IN FILE */

^IMAGE_HISTOGRAM               = 4
^IMAGE                          = 6

/*          IMAGE DESCRIPTION */

DATA_SET_ID                    = "VO1/VO2-M-VIS-5-DIM-V1.0"
PRODUCT_ID                     = "MG15N022-GRN-666A"
SPACECRAFT_NAME                 = VIKING_ORBITER_1
TARGET_NAME                     = MARS
START_TIME                      = 1978-01-14T02:00:00
STOP_TIME                       = 1978-01-14T02:00:00
SPACECRAFT_CLOCK_START_TIME     = UNK
SPACECRAFT_CLOCK_STOP_TIME      = UNK
PRODUCT_CREATION_TIME           = 1995-01-01T00:00:00
ORBIT_NUMBER                    = 666
FILTER_NAME                     = GREEN
IMAGE_ID                        = "MG15N022-GRN-666A"
INSTRUMENT_NAME                 = {VISUAL_IMAGING_SUBSYSTEM_CAMERA_A,
                                  VISUAL_IMAGING_SUBSYSTEM_CAMERA_B}
NOTE                            = "MARS MULTI-SPECTRAL MDIM SERIES"

/* SUN RAYS EMISSION, INCIDENCE, AND PHASE ANGLES OF IMAGE CENTER*/

SOURCE_PRODUCT_ID              = "666A36"
EMISSION_ANGLE                  = 21.794
INCIDENCE_ANGLE                 = 66.443
PHASE_ANGLE                     = 46.111

/*          DESCRIPTION OF OBJECTS CONTAINED IN FILE */

OBJECT                          = IMAGE_HISTOGRAM
  ITEMS                          = 256
  DATA_TYPE                     = VAX_INTEGER
  ITEM_BYTES                     = 4
END_OBJECT                      = IMAGE_HISTOGRAM

OBJECT                          = IMAGE
  LINES                          = 960
  LINE_SAMPLES                   = 956
  SAMPLE_TYPE                    = UNSIGNED_INTEGER
  SAMPLE_BITS                    = 8
  SAMPLE_BIT_MASK                = 2#11111111#
  CHECKSUM                       = 65718982

/* I/F = SCALING_FACTOR*DN + OFFSET, CONVERT TO INTENSITY/FLUX */

```

```
SCALING_FACTOR          = 0.001000
OFFSET                  = 0.0

/* OPTIMUM COLOR STRETCH FOR DISPLAY OF COLOR IMAGES */

STRETCHED_FLAG          = FALSE
STRETCH_MINIMUM         = ( 53, 0)
STRETCH_MAXIMUM         = (133,255)
END_OBJECT              = IMAGE

END
```

## A.19 HISTORY

A HISTORY object is a dynamic description of the history of one or more associated data objects in a file. It supplements the essentially static description contained in the PDS label.

The HISTORY object contains text in a format similar to that of the ODL statements used in the label. It identifies previous computer manipulation of the principal data object(s) in the file. It includes an identification of the source data, processes performed, processing parameters, as well as dates and times of processing. It is intended that the history be available for display, be dynamically extended by any process operating on the data, and be automatically propagated to the resulting data file. Eventually, it might be extracted for loading in detailed level catalogs of data set contents.

The HISTORY object is structured as a series of History Entries, one for each process which has operated on the data. Each entry contains a standard set of ODL element assignment statements, delimited by “GROUP = *program\_name*” and “END\_GROUP = *program\_name*” statements. A subgroup in each entry, delimited by “GROUP = PARAMETERS” and “END\_GROUP = PARAMETERS”, contains statements specifying the values of all parameters of the program.

### A.19.1 HISTORY ENTRY ELEMENTS

Attribute	Description
VERSION_DATE	Program version date, ISO standard format.
DATE_TIME	Run date and time, ISO standard format.
NODE_NAME	Network name of computer.
USER_NAME	Username.
SOFTWARE_DESC	Program-generated (brief) description.
USER_NOTE	User-supplied (brief) description.

Unlike the above elements, the names of the parameters defined in the PARAMETERS subgroup are uncontrolled, and must only conform to the program.

The last entry in a HISTORY object is followed by an END statement. The HISTORY object, by convention, follows the PDS label of the file, beginning on a record boundary, and is located by a pointer statement in the label. There are no required elements for the PDS label description of the object; it is represented in the label only by the pointer statement, and OBJECT = HISTORY and END\_OBJECT = HISTORY statements.

The HISTORY capability has been implemented as part of the Integrated Software for Imaging Spectrometers (ISIS) system (see QUBE object definition). ISIS QUBE applications add their own entries to the QUBE file’s cumulative HISTORY object. ISIS programs run under NASA’s TAE (Transportable Applications Executive) system, and are able to automatically insert all parameters of their TAE procedure into the HISTORY entry created by the program. Consult the

ISIS System Design document for details and limitations imposed by that system. (See the QUBE object description for further references.)

### **A.19.2 Required Keywords**

None

### **A.19.3 Optional Keywords**

None

### **A.19.4 Required Objects**

None

### **A.19.5 Optional Objects**

None

### **A.19.6 Example**

The following single-entry HISTORY object is from a Vicar-generated PDS-labeled QUBE file. (See the QUBE object example.) There is only one entry because the QUBE (or rather its label) was generated by a single program, VISIS. A QUBE generated by multiple ISIS programs would have multiple history entries, represented by multiple GROUPs in the HISTORY object.

The diagram following illustrates the placement of the example HISTORY object within a QUBE data product with an attached PDS label.

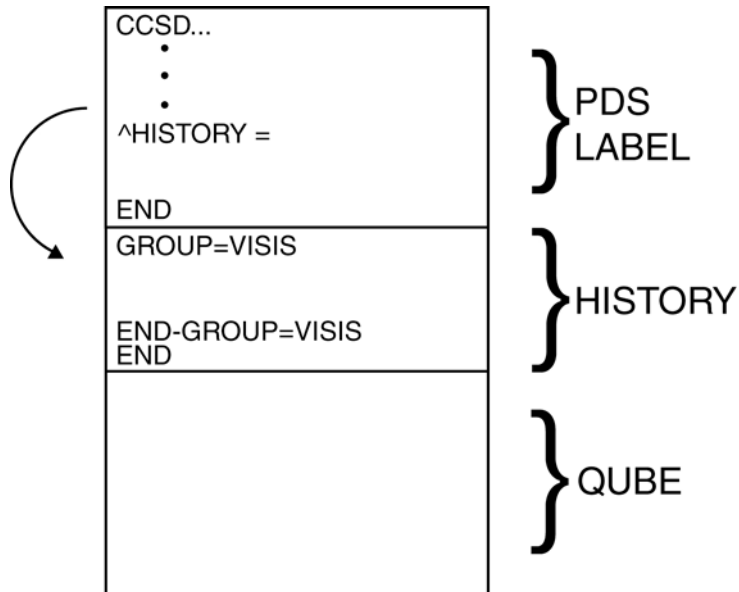

```

OBJECT                = HISTORY
GROUP                 = VISIS

VERSION_DATE          = 1990-11-08
DATE_TIME             = 1991-07-25T10:12:52
SOFTWARE_DESC         = "ISIS cube file with PDS label has
                        been generated as systematic product by MIPL using the following
                        programs:

                        NIMSMERGE to create EDR's;
                        NIMSCMM to create the merged mosaic & geometry cube;
                        HIST2D to create a two-dimensional histogram;
                        SPECPLOT to create the spectral plots;
                        TRAN, F2, and INSERT3D to create the SII cube;
                        VISIS to create the ISIS cube."
USER_NOTE              = "VPDIN1/ Footprint, Limbfit,
                        Height=50"

GROUP                 = PARAMETERS
  EDR_FILE_NAME        = " "
                        /*EDR accessed through MIPL Catalog*/
  IMAGE_ID             = NULL
  SPICE_FILE_NAME      = "N/A"
  SPIKE_FILE_NAME      = "MIPL:[MIPL.GLL]BOOM_OBSCURATION.NIM"
  DARK_VALUE_FILE_NAME = "N/A"
  CALIBRATION_FILE_NAME = "NDAT:NIMSGS2.CAL"
  MERGED_MOSAIC_FILE_NAME = "NDAT:VPDIN1_DN_FP_LF_H50.CUB"
  DARK_INTERPOLATION_TYPE = NOUPDAT
  PHOTOMETRIC_CORRECTION_TYPE = NONE
  CUBE_NIMSEL_TYPE     = NOCAL
  BINNING_TYPE         = FOOTPRNT
  FILL_BOX_SIZE        = 0
  FILL_MIN_VALID_PIXELS = 0
  SUMMARY_IMAGE_RED_ID = 0

```

```
SUMMARY_IMAGE_GREEN_ID      = 0
SUMMARY_IMAGE_BLUE_ID       = 0
ADAPT_STRETCH_SAT_FRAC      = 0.000000
ADAPT_STRETCH_SAMP_FRAC     = 0.000000
RED_STRETCH_RANGE           = ( 0, 0)
GREEN_STRETCH_RANGE         = ( 0, 0)
BLUE_STRETCH_RANGE          = ( 0, 0)
END_GROUP                   = PARAMETERS
END_GROUP                    = VISIS
END_OBJECT                   = HISTORY
END
```

## A.20 IMAGE

An IMAGE object is a two-dimensional array of values, all of the same type, each of which is referred to as a *sample*. IMAGE objects are normally processed with special display tools to produce a visual representation of the samples by assigning brightness levels or display colors to the values. An IMAGE consists of a series of lines, each containing the same number of samples.

The required IMAGE keywords define the parameters for simple IMAGE objects:

- LINES is the number of lines in the image.
- LINE\_SAMPLES is the number of samples in each line.
- SAMPLE\_BITS is the number of bits in each individual sample.
- SAMPLE\_TYPE defines the sample data type.

In more complex images, each individual line may have some attached data which are not part of the image itself (engineering data, checksums, time tags, etc.). In this case the additional, non-image parameters are accounted for as either LINE\_PREFIX\_BYTES or LINE\_SUFFIX\_BYTES, depending on whether they occur before or after the image samples in the line. These keywords indicate the total number of bytes used for the additional data, so that software processing the image can clip these bytes before attempting to display or manipulate the image. The structure of the prefix or suffix bytes is most often defined by a TABLE object (in the same label), which will itself have ROW\_SUFFIX\_BYTES or ROW\_PREFIX\_BYTES, to allow table-processing software to skip over the image data. Figure A.1 illustrates the layout of prefix and suffix bytes around an image.

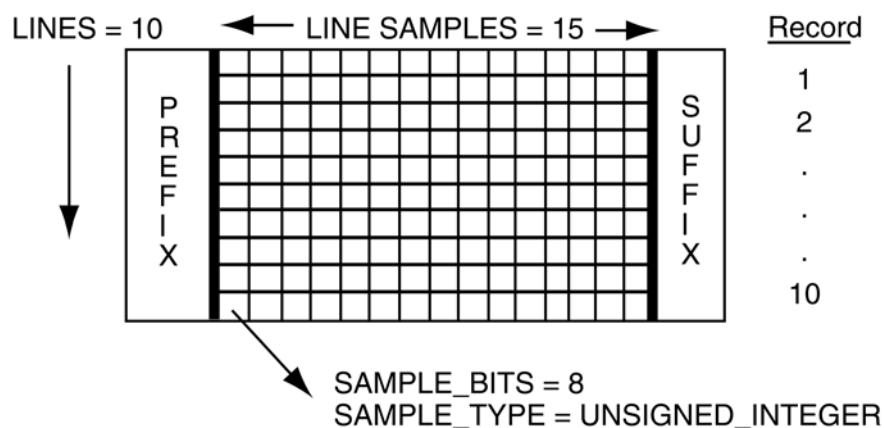

*Figure A.1 – Prefix and Suffix Bytes Attached to an Image*



Sometimes a single image is composed of several bands of data. For example, a color image for video display may actually consist of three copies of the image: one in red, one in green and one in blue. Each logical sample corresponds to one value for each of the bands. In this case, the keyword BANDS is used to indicate the presence of multiple bands of data.

BAND\_STORAGE\_TYPE indicates how the banded values are organized:

- SAMPLE\_INTERLEAVED means that in each line, all band values for each sample are adjacent in the line. So in the above example of an RGB image, each line would look like this (numbers are sample numbers, RGB = red, green, blue):

```
1R 1G 1B  2R 2G 2B  3R 3G 3B  ...
```

- LINE\_INTERLEAVED means that successive lines contain the band values for corresponding samples. Continuing with the RGB example, the first physical lines in the image data would represent the first display line of the image, first in red, then green, then blue:

```
1R 2R 3R 4R  ...
1G 2G 3G 4G  ...
1B 2B 3B 4B  ...
```

By default, IMAGE objects should be displayed so that the lines are drawn from left to right and top to bottom. Other organizations can be indicated by using the LINE\_DISPLAY\_DIRECTION and SAMPLE\_DISPLAY\_DIRECTION keywords. Figure A.2 illustrates band storage schemes and the related keyword values.

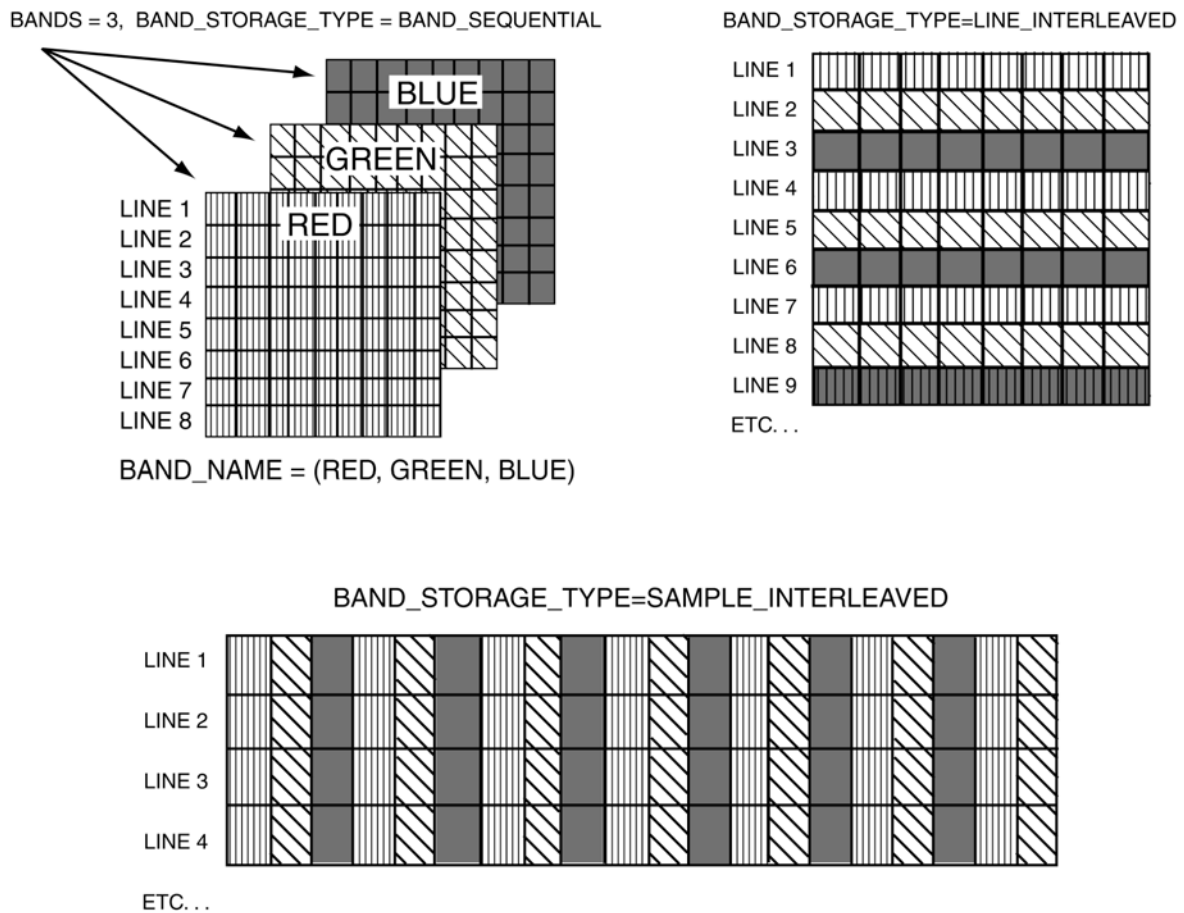

*Figure A.2 – Keywords for a Multi-Band Image*

### A.20.1 Required Keywords

1. LINES
2. LINE\_SAMPLES
3. SAMPLE\_TYPE
4. SAMPLE\_BITS

### A.20.2 Optional Keywords

1. BAND\_SEQUENCE
2. BAND\_STORAGE\_TYPE
3. BANDS
4. CHECKSUM
5. DERIVED\_MAXIMUM

6. DERIVED\_MINIMUM
7. DESCRIPTION
8. ENCODING\_TYPE
9. FIRST\_LINE
10. FIRST\_LINE\_SAMPLE
11. INVALID\_CONSTANT
12. LINE\_PREFIX\_BYTES
13. LINE\_SUFFIX\_BYTES
14. MISSING\_CONSTANT
15. OFFSET
16. SAMPLE\_BIT\_MASK
17. SAMPLING\_FACTOR
18. SCALING\_FACTOR
19. SOURCE\_FILE\_NAME
20. SOURCE\_LINES
21. SOURCE\_LINE\_SAMPLES
22. SOURCE\_SAMPLE\_BITS
23. STRETCHED\_FLAG
24. STRETCH\_MINIMUM
25. STRETCH\_MAXIMUM

### A.20.3 Required Objects

None

### A.20.4 Optional Objects

None

### A.20.5 Example

This is an example of an (attached) IMAGE label for a color digital mosaic image from the Mars Digital Image Map CD-ROMs. It includes a CHECKSUM to support automated volume production and validation, a SCALING\_FACTOR to indicate the relationship between sample values and geophysical parameters and stretch keywords to indicate optimal values for image display.

PDS_VERSION_ID	=	PDS3
RECORD_TYPE	=	FIXED_LENGTH
RECORD_BYTES	=	956
FILE_RECORDS	=	965
LABEL_RECORDS	=	3

```

^IMAGE_HISTOGRAM      = 4
^IMAGE                = 6

DATA_SET_ID           = "VO1/VO2-M-VIS-5-DIM-V1.0"
PRODUCT_ID            = "MG15N022-GRN-666A"
SPACECRAFT_NAME       = VIKING_ORBITER_1
TARGET_NAME           = MARS
IMAGE_TIME            = 1978-01-14T02:00:00
START_TIME            = UNK
STOP_TIME             = UNK
SPACECRAFT_CLOCK_START_COUNT = UNK
SPACECRAFT_CLOCK_STOP_COUNT = UNK
PRODUCT_CREATION_TIME = 1995-01-01T00:00:00
ORBIT_NUMBER          = 666
FILTER_NAME           = GREEN
IMAGE_ID              = "MG15N022-GRN-666A"
INSTRUMENT_NAME       = {VISUAL_IMAGING_SUBSYSTEM_CAMERA_A,
                          VISUAL_IMAGING_SUBSYSTEM_CAMERA_B}
NOTE                  = "MARS MULTI-SPECTRAL MDIM SERIES"
SOURCE_PRODUCT_ID     = "666A36"
EMISSION_ANGLE        = 21.794
INCIDENCE_ANGLE       = 66.443
PHASE_ANGLE           = 46.111

/* DESCRIPTION OF OBJECTS CONTAINED IN FILE */

OBJECT                = IMAGE_HISTOGRAM
  ITEMS               = 256
  DATA_TYPE          = VAX_INTEGER
  ITEM_BYTES          = 4
END_OBJECT            = IMAGE_HISTOGRAM

OBJECT                = IMAGE
  LINES               = 960
  LINE_SAMPLES        = 956
  SAMPLE_TYPE         = UNSIGNED_INTEGER
  SAMPLE_BITS         = 8
  SAMPLE_BIT_MASK     = 2#11111111#
  CHECKSUM            = 65718982
  SCALING_FACTOR      = 0.001000
                      /* I/F = scaling factor*DN+offset, */
                      /* convert to intensity/flux.      */
  OFFSET              = 0.0
  STRETCHED_FLAG      = FALSE
                      /* Optimum color stretch for display */
                      /* of color images.                  */
  STRETCH_MINIMUM     = ( 53, 0)
  STRETCH_MAXIMUM     = (133,255)
END_OBJECT            = IMAGE

END

```

## A.21 INDEX\_TABLE

The INDEX\_TABLE object is a specific type of a TABLE object that provides information about the data stored on an archive volume. The INDEX\_TABLE contains one row for each data file (or data product label file, in the case where detached labels are used) on the volume. The table is formatted so that it may be read directly by many data management systems on various host computers: all fields (columns) are separated by commas; character fields are enclosed in double quotation marks; and each record ends in a carriage return/line feed sequence.

The columns of an INDEX\_TABLE contain path information for each file, plus values extracted from keywords in the PDS labels. Columns are selected to allow users to a) search the table for specific files of interest; and b) identify the exact location of the file both on the volume and in the PDS catalog. In general, the columns listed in Section A.20.5.1 as *optional* are used for searching the table; the *required* columns listed in Section A.20.4.1 provide the identification information for each file. Where possible the PDS keyword name should be used as the NAME value in the corresponding COLUMN definition.

**Note:** See Section 17.2 for information about the use of the constants “N/A”, “UNK” and “NULL” in an INDEX\_TABLE.

### A.21.1 INDEX\_TABLEs Under Previous Version of the Standards

Prior to version 3.2 of the Standards, the INDEX\_TYPE keyword was optional. Cumulative indices were identified by their filenames, which were (and still are) of the form “CUMINDEX.TAB” or “*axx*CMIDX.TAB” (with *axx* representing up to three alphanumeric characters). So, when INDEX\_TYPE is not present, it defaults to “CUMULATIVE” in cumulative index files (that is, file with filenames as above) and “SINGLE” in all other index files.

### A.21.2 Required Keywords

1. INTERCHANGE\_FORMAT
2. ROWS
3. COLUMNS
4. ROW\_BYTES
5. INDEX\_TYPE

### A.21.3 Optional Keywords

1. NAME
2. DESCRIPTION
3. INDEXED\_FILE\_NAME

4. UNKNOWN\_CONSTANT
5. NOT\_APPLICABLE\_CONSTANT

### A.21.4 Required Objects

1. COLUMN

#### A.21.4.1 Required COLUMN Objects

The following COLUMN objects (as identified by the COLUMN\_NAME keyword) are required to be included in the INDEX\_TABLE object:

#### COLUMN\_NAME

---

1. FILE\_SPECIFICATION\_NAME, or PATH\_NAME and FILE\_NAME
2. PRODUCT\_ID \*\*
3. VOLUME\_ID \*
4. DATA\_SET\_ID \*
5. PRODUCT\_CREATION\_TIME \*
6. LOGICAL\_VOLUME\_PATH\_NAME \* (must be used with PATH\_NAME and FILE\_NAME for a logical volume)

\* If the value is constant across the data in the index table, this keyword can appear in the index table's label. If the value is not constant, then a column of the given name must be used.

\*\* PRODUCT\_ID is not required if it has the same value as FILE\_NAME or FILE\_SPECIFICATION\_NAME.

#### A.21.4.2 Required Keywords (for Required COLUMN Objects)

1. NAME
2. DATA\_TYPE
3. START\_BYTE
4. BYTES
5. DESCRIPTION

### A.21.5 Optional Objects

None

#### A.21.5.1 Optional COLUMN Objects (NAME=)



```

OBJECT          = COLUMN
  NAME          = DATA_SET_ID
  DESCRIPTION   = "The data set identifier. Acceptable
                 values include 'MO-M-RSS-1-OIDR-V1.0'"
  DATA_TYPE    = CHARACTER
  START_BYTE   = 14
  BYTES        = 25
END_OBJECT

OBJECT          = COLUMN
  NAME          = PATH_NAME
  DESCRIPTION   = "Path to directory containing file.
                 Acceptable values include:
                 'AMD',
                 'ION',
                 'TIM',
                 'TRO',
                 'WEA',
                 'LIT',
                 'MIF',
                 'MPD',
                 'ODF',
                 'ODR',
                 'ODS',
                 'SFO',
                 'SOE', and
                 'TDF'."
  DATA_TYPE    = CHARACTER
  START_BYTE   = 42
  BYTES        = 9
END_OBJECT

OBJECT          = COLUMN
  NAME          = FILE_NAME
  DESCRIPTION   = "Name of file in archive"
  DATA_TYPE    = CHARACTER
  START_BYTE   = 54
  BYTES        = 12
END_OBJECT

OBJECT          = COLUMN
  NAME          = PRODUCT_ID
  DESCRIPTION   = "Original file name on MO PDB or SOPC"
  DATA_TYPE    = CHARACTER
  START_BYTE   = 69
  BYTES        = 33
END_OBJECT

OBJECT          = COLUMN
  NAME          = START_TIME
  DESCRIPTION   = "Time at which data in the file begin
                 given in the format 'YYYY-MM-DDThh:mm:ss'."
  DATA_TYPE    = CHARACTER
  START_BYTE   = 105

```



```
    BYTES = 19
END_OBJECT = COLUMN

OBJECT = COLUMN
  NAME = STOP_TIME
  DESCRIPTION = "Time at which data in the file end
given in the format 'YYYY-MM-DDThh:mm:ss'."
  DATA_TYPE = CHARACTER
  START_BYTE = 127
  BYTES = 19
END_OBJECT = COLUMN

OBJECT = COLUMN
  NAME = PRODUCT_CREATION_TIME
  DESCRIPTION = "Date and time that file was created."
  DATA_TYPE = CHARACTER
  START_BYTE = 149
  BYTES = 19
END_OBJECT = COLUMN

OBJECT = COLUMN
  NAME = FILE_SIZE
  DESCRIPTION = "Number of bytes in file, not including
label."
  DATA_TYPE = "ASCII INTEGER"
  START_BYTE = 170
  BYTES = 9
END_OBJECT = COLUMN

END_OBJECT = INDEX_TABLE
END
```

## A.22 PALETTE

The PALETTE object, a sub-class of the TABLE object, contains entries which represent color table assignments for values (i.e., SAMPLEs) contained in an IMAGE.

If the PALETTE is stored in a separate file from the IMAGE object, then it should be stored in ASCII format as 256 rows, each with 4 columns. The first column contains the SAMPLE value (running from 0–255 for an 8-bit SAMPLE, for example), and the remaining three columns contain the relative amount (a value from 0 to 255) of each primary color to be assigned for that SAMPLE value.

If the PALETTE is stored in the same file as the IMAGE object, then the PALETTE should be stored in BINARY format as 256 consecutive 8-bit values for each primary color (RED, GREEN, BLUE) resulting in a 768-byte record.

### A.22.1 Required Keywords

1. INTERCHANGE\_FORMAT
2. ROWS
3. ROW\_BYTES
4. COLUMNS

### A.22.2 Optional Keywords

1. DESCRIPTION
2. NAME

### A.22.3 Required Objects

1. COLUMN

### A.22.4 Optional Objects

None

### A.22.5 Example

The examples below illustrate both types of PALETTE objects (ASCII and BINARY). The first is example is a complete label for an ASCII PALETTE object:

```
PDS_VERSION_ID          = PDS3
```

```

RECORD_TYPE           = FIXED_LENGTH
RECORD_BYTES         = 80
FILE_RECORDS         = 256
^PALETTE             = "PALETTE.TAB"

/* Image Palette description */
SPACECRAFT_NAME      = MAGELLAN
MISSION_PHASE_NAME   = PRIMARY_MISSION
TARGET_NAME          = VENUS
PRODUCT_ID           = "GEDR-MERC.1;2"
IMAGE_ID              = "GEDR-MERC.1;2"
INSTRUMENT_NAME      = "RADAR SYSTEM"
PRODUCT_CREATION_TIME = 1995-01-01T00:00:00
NOTE                  = "Palette for browse image"

/* Description of an ASCII PALETTE object */

OBJECT                = PALETTE
  INTERCHANGE_FORMAT  = ASCII
  ROWS                 = 256
  ROW_BYTES           = 80
  COLUMNS             = 4

  OBJECT                = COLUMN
    NAME                 = SAMPLE
    DESCRIPTION           = "DN value for red, green, blue
                           intensities"
    DATA_TYPE            = ASCII_INTEGER
    START_BYTE           = 1
    BYTES                 = 3
  END_OBJECT

  OBJECT                = COLUMN
    NAME                 = RED
    DESCRIPTION           = "Red intensity (0 - 255)"
    DATA_TYPE            = ASCII_INTEGER
    START_BYTE           = 6
    BYTES                 = 3
  END_OBJECT

  OBJECT                = COLUMN
    NAME                 = GREEN
    DESCRIPTION           = "Green intensity (0 - 255)"
    DATA_TYPE            = ASCII_INTEGER
    START_BYTE           = 11
    BYTES                 = 3
  END_OBJECT

  OBJECT                = COLUMN
    NAME                 = BLUE
    DESCRIPTION           = "Blue intensity (0 - 255)"
    DATA_TYPE            = ASCII_INTEGER
    START_BYTE           = 16
    BYTES                 = 3
  END_OBJECT

```

```

    END_OBJECT
END_OBJECT
END

```

This label fragment illustrates the definition of a binary PALETTE object:

```

/* Description of a BINARY PALETTE object */

OBJECT                = PALETTE
  INTERCHANGE_FORMAT = BINARY
  ROWS                = 1
  ROW_BYTES           = 768
  COLUMNS            = 3

OBJECT                = COLUMN
  NAME                = RED
  DATA_TYPE          = UNSIGNED_INTEGER
  START_BYTE         = 1
  ITEMS               = 256
  ITEM_BYTES         = 1
END_OBJECT           = COLUMN

OBJECT                = COLUMN
  NAME                = GREEN
  DATA_TYPE          = UNSIGNED_INTEGER
  START_BYTE         = 257
  ITEMS               = 256
  ITEM_BYTES         = 1
END_OBJECT           = COLUMN

OBJECT                = COLUMN
  NAME                = BLUE
  DATA_TYPE          = UNSIGNED_INTEGER
  START_BYTE         = 513
  ITEMS               = 256
  ITEM_BYTES         = 1
END_OBJECT           = COLUMN
END_OBJECT           = PALETTE

```

## A.23 QUBE

A generalized QUBE object is a multidimensional array (called the core) of sample values in multiple dimensions. The core is homogeneous, and consists of unsigned byte, signed halfword or floating point fullword elements. QUBEs of one to three dimensions may have optional suffix areas in each axis. The suffix areas may be heterogeneous, with elements of different types, but each suffix pixel is always allocated a full word. Special values may be defined for the core and the suffix areas to designate missing values and several kinds of invalid values, such as instrument and representation saturation.

The QUBE is the principal data structure of the ISIS (Integrated Software for Imaging Spectrometers) system. A frequently used specialization of the QUBE object is the ISIS Standard Qube, which is a three-dimensional QUBE with two spatial dimensions and one spectral dimension. Its axes have the interpretations 'sample', 'line' and 'band'. Three physical storage orders are allowed: band-sequential, line\_interleaved (band-interleaved-by-line) and sample\_interleaved (band-interleaved-by-pixel).

An example of a Standard ISIS Qube is a spectral image qube containing data from an imaging spectrometer. Such a qube is simultaneously a set of images (at different wavelengths) of the same target area, and a set of spectra at each point of the target area. Typically, suffix areas in such a qube are confined to 'backplanes' containing geometric or quality information about individual spectra, i.e. about the set of corresponding values at the same pixel location in each band.

The following diagram illustrates the general structure of a Standard ISIS Qube. Note that this is a conceptual or "logical" view of the qube.

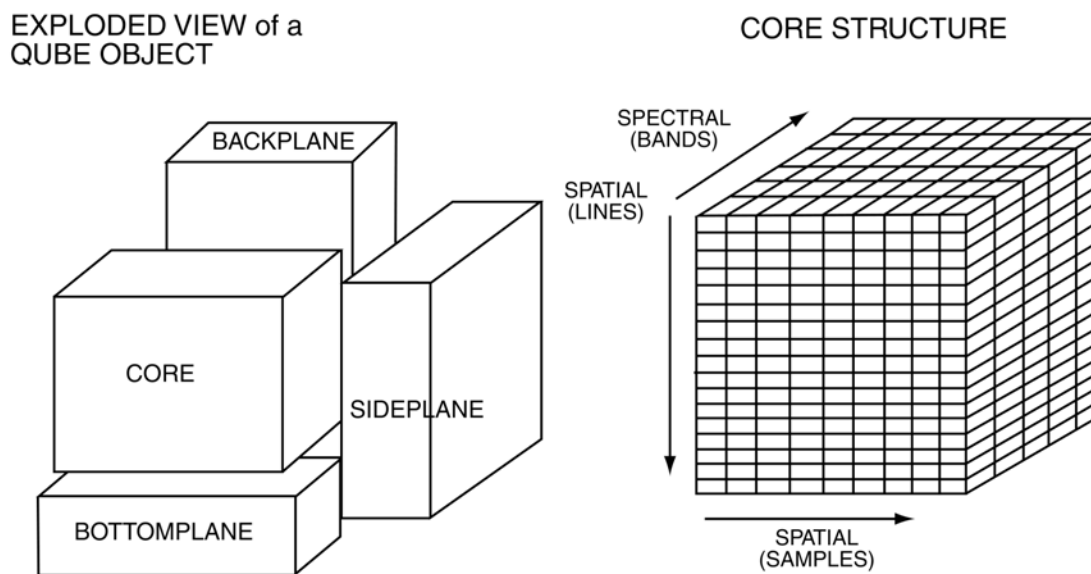

*Figure A.3 – Exploded View of a Qube Object*

Some special requirements are imposed by the ISIS system. A QUBE object must be associated with a HISTORY object. (Other objects, such as HISTOGRAMs, IMAGEs, PALETTEs and TABLEs which contain statistics, display parameters, engineering values or other ancillary data, are optional.) A special element, FILE\_STATE, is required in the implicit FILE object. Some label information is organized into GROUPs, such as BAND\_BIN and IMAGE\_MAP\_PROJECTION. The BAND\_BIN group contains essential wavelength information, and is required for Standard ISIS Qubes.

The ISIS system includes routines for reading and writing files containing QUBE objects. Both 'logical' access, independent of actual storage order, and direct 'physical' access are provided for Standard ISIS Qubes. Only physical access is provided for generalized QUBEs. Most ISIS application programs operate on Standard ISIS Qubes. Arbitrary subqubes ('virtual' qubes) of existing qubes may be specified for most of these programs. In addition, ISIS includes software for handling Tables (an ISIS variant of the PDS Table object) and Instrument Spectral Libraries.

For a complete description, refer to the most recent version of "ISD: ISIS System Design, Build 2", obtainable from the PDS Operator.

NOTE: The following required and optional elements of the QUBE object are ISIS-specific. Since the ISIS system was designed before the current version of the Planetary Science Data Dictionary, some of the element names conflict with current PDS nomenclature standards.

### A.23.1 Required Keywords (Generalized Qube and Standard ISIS Qube)

AXES	Number of axes or dimensions of qube [integer]
AXIS_NAME	Names of axes [sequence of 1-6 literals] (BAND, LINE, SAMPLE) for Standard Qube
CORE_ITEMS	Core dimensions of axes [seq of 1-6 integers]
CORE_ITEM_BYTES	Core element size [integer bytes: {1, 2, 4}]
CORE_ITEM_TYPE	Core element type [literal: {UNSIGNED_INTEGER, INTEGER, REAL}]
CORE_BASE	Base value of core item scaling [real]
CORE_MULTIPLIER	Multiplier for core item scaling [real] 'true' value = base + multiplier * 'stored' value (base = 0.0 and multiplier = 1.0 for REALs)
SUFFIX_BYTES	Storage allocation of suffix elements [integer: always 4]
SUFFIX_ITEMS	Suffix dimensions of axes [seq of 1-6 integers]

CORE_VALID_MINIMUM	Minimum valid core value -- values below this value are reserved for 'special' values, of which 5 are currently assigned [integer or non-decimal integer: these values are fixed by ISIS convention for each allowable item type and size -- see ISD for details]
CORE_NULL	Special value indicating 'invalid' data
CORE_LOW_INSTR_SATURATION	Special value indicating instrument saturation at the low end
CORE_HIGH_INSTR_SATURATION	Special value indicating instrument saturation at the high end
CORE_LOW_REPR_SATURATION	Special value indicating representation saturation at the low end
CORE_HIGH_REPR_SATURATION	Special value indicating representation saturation at the high end

### **A.23.2 Required Keywords (Standard ISIS Qube) and Optional Keywords (Generalized Qube)**

CORE_NAME	Name of value stored in core of qube [literal, e.g. SPECTRAL_RADIANCE]
CORE_UNIT	Unit of value stored in core of qube [literal]
BAND_BIN_CENTER	Wavelengths of bands in a Standard Qube [sequence of reals]
BAND_BIN_UNIT	Unit of wavelength [literal, e.g. MICROMETER]
BAND_BIN_ORIGINAL_BAND	Original band numbers, referring to a Qube of which the current qube is a subqube. In the original qube, these are sequential integers.[sequence of integers]

### **A.23.3 Optional Keywords (Generalized Qube and Standard ISIS Qube)**

BAND_BIN_WIDTH	Width (at half height) of spectral response of bands [sequence of reals]
BAND_BIN_STANDARD_DEVIATION	Standard deviation of spectrometer values at each band [sequence of reals]
BAND_BIN_DETECTOR	Instrument detector number of band, where relevant [sequence of integers]

BAND\_BIN\_GRATING\_POSITION      Instrument grating position of band, where relevant  
[sequence of integers]

#### A.23.3.1      **Required Keywords (for each suffix present in a 1-3 dimensional qube):**

Note: These must be prefixed by the specific AXIS\_NAME. These are SAMPLE, LINE and BAND for Standard ISIS Qubes. Only the commonly used BAND variants are shown:

BAND_SUFFIX_NAME	Names of suffix items [sequence of literals]
BAND_SUFFIX_UNIT	Units of suffix items [sequence of literals]
BAND_SUFFIX_ITEM_BYTES	Suffix item sizes [sequence of integer bytes {1, 2, 4}]
BAND_SUFFIX_ITEM_TYPE	Suffix item types [sequence of literals: {UNSIGNED_INTEGER, INTEGER, REAL, ...}]
BAND_SUFFIX_BASE	Base values of suffix item scaling [sequence of reals] (see corresponding core element)
BAND_SUFFIX_MULTIPLIER	Multipliers for suffix item scaling [sequence of reals] (see corresponding core element)
BAND_SUFFIX_VALID_MINIMUM	Minimum valid suffix values
BAND_SUFFIX_NULL	...and assigned special values
BAND_SUFFIX_LOW_INSTR_SAT	[sequences of integers or reals]
BAND_SUFFIX_HIGH_INSTR_SAT	(see corresponding core
BAND_SUFFIX_LOW_REPR_SAT	element definitions for
BAND_SUFFIX_HIGH_REPR_SAT	details)

#### A.23.4      **Example**

The following label describes ISIS QUBE data from the Galileo NIMS experiment. The QUBE contains 17 bands of NIMS fixed-map mode raw data numbers and 9 backplanes of ancillary information. In other modes, NIMS can produce data qubes of 34, 102, 204 and 408 bands.



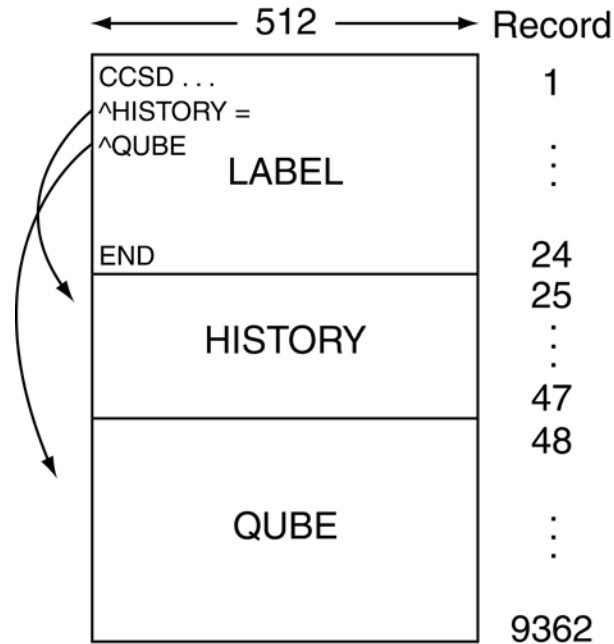

```
PDS_VERSION_ID = PDS3
/* File Structure */
```

```
RECORD_TYPE           = FIXED_LENGTH
RECORD_BYTES          = 512
FILE_RECORDS          = 9158
LABEL_RECORDS         = 24
FILE_STATE            = CLEAN
```

```
^HISTORY              = 25
OBJECT                = HISTORY
END_OBJECT            = HISTORY
```

```
^QUBE                = 48
OBJECT                = QUBE
```

```
/* Qube structure: Standard ISIS QUBE of NIMS Data */
```

```
AXES                  = 3
AXIS_NAME             = (SAMPLE,LINE,BAND)
```

```
/* Core description */
```

```
CORE_ITEMS           = (229,291,17)
CORE_ITEM_BYTES      = 2
CORE_ITEM_TYPE       = VAX_INTEGER
CORE_BASE            = 0.0
CORE_MULTIPLIER      = 1.0
CORE_VALID_MINIMUM   = -32752
CORE_NULL            = -32768
CORE_LOW_REPR_SATURATION = -32767
CORE_LOW_INSTR_SATURATION = -32766
```

```

CORE_HIGH_INSTR_SATURATION = -32765
CORE_HIGH_REPR_SATURATION = -32764
CORE_NAME                  = RAW_DATA_NUMBER
CORE_UNIT                  = DIMENSIONLESS
PHOTOMETRIC_CORRECTION_TYPE = NONE

/* Suffix description */

SUFFIX_BYTES                = 4
SUFFIX_ITEMS               = (0,0,9)
BAND_SUFFIX_NAME           = (LATITUDE, LONGITUDE, INCIDENCE_ANGLE,
    EMISSION_ANGLE, PHASE_ANGLE, SLANT_DISTANCE, INTERCEPT_ALTITUDE,
    PHASE_ANGLE_STD_DEV, RAW_DATA_NUMBER_STD_DEV)
BAND_SUFFIX_UNIT           = (DEGREE, DEGREE, DEGREE, DEGREE, DEGREE,
    KILOMETER, KILOMETER, DEGREE, DIMENSIONLESS)
BAND_SUFFIX_ITEM_BYTES     = (4,4,4,4,4,4,4,4,4,4)
BAND_SUFFIX_ITEM_TYPE      = (VAX_REAL, VAX_REAL, VAX_REAL, VAX_REAL,
    VAX_REAL, VAX_REAL, VAX_REAL, VAX_REAL, VAX_REAL)
BAND_SUFFIX_BASE           = (0.000000, 0.000000, 0.000000, 0.000000,
    0.000000, 0.000000, 0.000000, 0.000000, 0.000000)
BAND_SUFFIX_MULTIPLIER     = (1.000000, 1.000000, 1.000000, 1.000000,
    1.000000, 1.000000, 1.000000, 1.000000, 1.000000)
BAND_SUFFIX_VALID_MINIMUM  = (16#FFFFFFFF#, 16#FFFFFFFF#,
    16#FFFFFFFF#, 16#FFFFFFFF#, 16#FFFFFFFF#, 16#FFFFFFFF#,
    16#FFFFFFFF#, 16#FFFFFFFF#, 16#FFFFFFFF#)
BAND_SUFFIX_NULL           = (16#FFFFFFFF#, 16#FFFFFFFF#,
    16#FFFFFFFF#, 16#FFFFFFFF#, 16#FFFFFFFF#, 16#FFFFFFFF#,
    16#FFFFFFFF#, 16#FFFFFFFF#, 16#FFFFFFFF#)
BAND_SUFFIX_LOW_REPR_SAT   = (16#FFFFFFF#, 16#FFFFFFF#,
    16#FFFFFFF#, 16#FFFFFFF#, 16#FFFFFFF#, 16#FFFFFFF#,
    16#FFFFFFF#, 16#FFFFFFF#, 16#FFFFFFF#)
BAND_SUFFIX_LOW_INSTR_SAT  = (16#FFFDFFFF#, 16#FFFDFFFF#,
    16#FFFDFFFF#, 16#FFFDFFFF#, 16#FFFDFFFF#, 16#FFFDFFFF#,
    16#FFFDFFFF#, 16#FFFDFFFF#, 16#FFFDFFFF#)
BAND_SUFFIX_HIGH_INSTR_SAT = (16#FFFCFFFF#, 16#FFFCFFFF#,
    16#FFFCFFFF#, 16#FFFCFFFF#, 16#FFFCFFFF#, 16#FFFCFFFF#,
    16#FFFCFFFF#, 16#FFFCFFFF#, 16#FFFCFFFF#)
BAND_SUFFIX_HIGH_REPR_SAT  = (16#FFFBFFFF#, 16#FFFBFFFF#,
    16#FFFBFFFF#, 16#FFFBFFFF#, 16#FFFBFFFF#, 16#FFFBFFFF#,
    16#FFFBFFFF#, 16#FFFBFFFF#, 16#FFFBFFFF#)
BAND_SUFFIX_NOTE           = "The backplanes contain 7 geometric
    parameters, the standard deviation of one of them, the standard
    deviation of a selected data band, and 0 to 10 'spectral index'
    bands, each a user-specified function of the data bands. (See
    the BAND_SUFFIX_NAME values.)

```

Longitude ranges from 0 to 360 degrees, with positive direction specified by POSITIVE\_LONGITUDE\_DIRECTION in the IMAGE\_MAP\_PROJECTION group.

INTERCEPT\_ALTITUDE contains values for the DIFFERENCE between the length of the normal from the center of the target body to the line of sight AND the radius of the target body. On-target points have zero values. Points beyond the maximum expanded radius have

null values. This plane thus also serves as a set of 'off-limb' flags. It is meaningful only for the ORTHOGRAPHIC and POINT\_PERSPECTIVE projections; otherwise all values are zero. The geometric standard deviation backplane contains the standard deviation of the geometry backplane indicated in its NAME, except that the special value 16#FFF9FFFF# replaces the standard deviation where the corresponding core pixels have been 'filled'.

The data band standard deviation plane is computed for the NIMS data band specified by STD\_DEV\_SELECTED\_BAND\_NUMBER. This may be either a raw data number, or spectral radiance, whichever is indicated by CORE\_NAME.

The (optional) spectral index bands were generated by the Vicar F2 program. The corresponding BAND\_SUFFIX\_NAME is an abbreviated formula for the function used, where Bn should be read 'NIMS data band n'. For example: B4/B8 represents the ratio of bands 4 and 8."

```

STD_DEV_SELECTED_BAND_NUMBER = 9

/* Data description: general */

DATA_SET_ID           = "GO-V-NIMS-4-MOSAIC-V1.0"
PRODUCT_ID            = "XYZ"
SPACECRAFT_NAME       = GALILEO_ORBITER
MISSION_PHASE_NAME    = VENUS_ENCOUNTER
INSTRUMENT_NAME       = NEAR_INFRARED_MAPPING_SPECTROMETER
INSTRUMENT_ID         = NIMS
^INSTRUMENT_DESCRIPTION = "NIMSINST.TXT"

TARGET_NAME           = VENUS
START_TIME            = 1990-02-10T01:49:58
STOP_TIME             = 1990-02-10T02:31:52
NATIVE_START_TIME     = 180425.85
NATIVE_STOP_TIME      = 180467.34
OBSERVATION_NAME      = 'VPDIN1'
OBSERVATION_NOTE      = "VPDIN1 / Footprint, Limbfit,
                        Height=50"

INCIDENCE_ANGLE       = 160.48
EMISSION_ANGLE        = 14.01
PHASE_ANGLE           = 147.39
SUB_SOLAR_AZIMUTH     = -174.74
SUB_SPACECRAFT_AZIMUTH = -0.80
MINIMUM_SLANT_DISTANCE = 85684.10
MAXIMUM_SLANT_DISTANCE = 103175.00
MIN_SPACECRAFT_SOLAR_DISTANCE = 1.076102e+08
MAX_SPACECRAFT_SOLAR_DISTANCE = 1.076250e+08

/* Data description: instrument status */

INSTRUMENT_MODE_ID    = FIXED_MAP
GAIN_MODE_ID          = 2

```

```

CHOPPER_MODE_ID           = REFERENCE
START_GRATING_POSITION    = 16
OFFSET_GRATING_POSITION   = 04

MEAN_FOCAL_PLANE_TEMPERATURE = 85.569702
MEAN_RAD_SHIELD_TEMPERATURE = 123.636002
MEAN_TELESCOPE_TEMPERATURE = 139.604996
MEAN_GRATING_TEMPERATURE   = 142.580002
MEAN_CHOPPER_TEMPERATURE   = 142.449997
MEAN_ELECTRONICS_TEMPERATURE = 287.049988

GROUP                      = BAND_BIN

    BAND_BIN_CENTER        = (0.798777, 0.937873, 1.179840,
        1.458040, 1.736630, 2.017250, 2.298800, 2.579060, 2.864540,
        3.144230, 3.427810, 3.710640, 3.993880, 4.277290, 4.561400,
        4.843560, 5.126080)
    BAND_BIN_UNIT          = MICROMETER
    BAND_BIN_ORIGINAL_BAND = (1, 2, 3, 4, 5, 6, 7, 8, 9, 10, 11,
        12, 13, 14, 15, 16, 17)
    BAND_BIN_GRATING_POSITION = (16, 16, 16, 16, 16, 16, 16, 16, 16, 16,
        16, 16, 16, 16, 16, 16)
    BAND_BIN_DETECTOR      = (1, 2, 3, 4, 5, 6, 7, 8, 9, 10, 11,
        12, 13, 14, 15, 16, 17)
END_GROUP                  = BAND_BIN

GROUP                      = IMAGE_MAP_PROJECTION
    /* Projection description */
    MAP_PROJECTION_TYPE    = OBLIQUE_ORTHOGRAPHIC
    MAP_SCALE              = 45.000
    MAP_RESOLUTION         = 2.366
    CENTER_LATITUDE        = 12.00
    CENTER_LONGITUDE       = 350.00
    LINE_PROJECTION_OFFSET = 149.10
    SAMPLE_PROJECTION_OFFSET = 85.10
    MINIMUM_LATITUDE       = 11.71
    MAXIMUM_LATITUDE       = 13.62
    MINIMUM_LONGITUDE      = 349.62
    MAXIMUM_LONGITUDE      = 351.72
    POSITIVE_LONGITUDE_DIRECTION = EAST
    A_AXIS_RADIUS          = 6101.000000
    B_AXIS_RADIUS          = 6101.000000
    C_AXIS_RADIUS          = 6101.000000
    REFERENCE_LATITUDE     = 0.000000
    REFERENCE_LONGITUDE    = 0.000000
    MAP_PROJECTION_ROTATION = 0.00
    LINE_FIRST_PIXEL       = 1
    LINE_LAST_PIXEL        = 229
    SAMPLE_FIRST_PIXEL     = 1
    SAMPLE_LAST_PIXEL      = 291
END_GROUP                  = IMAGE_MAP_PROJECTION

END_OBJECT                 = QUBE
END

```

## A.24 SERIES

The SERIES object is a sub-class of the TABLE object. It is used for storing a sequence of measurements organized in a specific way (e.g., chronologically, by radial distance, etc.). The SERIES uses the same physical format specification as the TABLE object with additional sampling parameter information describing the variation between elements in the series. The sampling parameter keywords are required for the SERIES object itself, but are optional for the COLUMN sub-objects, depending on the data organization.

The sampling parameter keywords in the SERIES object represent the variation between the ROWS of data. For data with regularly-spaced rows, the SAMPLING\_PARAMETER\_INTERVAL keyword defines the row-to-row variation. For data in which rows are irregularly spaced, the SAMPLING\_PARAMETER\_INTERVAL keyword is “N/A” and the actual sampling parameter is included as a COLUMN in the SERIES.

When the data vary regularly across items of a single column, sampling parameter keywords appear as part of the COLUMN sub-object. Data sampled at irregular intervals described as separate columns may also provide sampling parameter information specific to each column.

Optional MINIMUM\_SAMPLING\_PARAMETER and MAXIMUM\_SAMPLING\_PARAMETER keywords should be added whenever possible to indicate the range in which the data were sampled. For data sampled at a single point rather than over a range, both the MINIMUM\_SAMPLING\_PARAMETER and MAXIMUM\_SAMPLING\_PARAMETER are set to the specific value.

The object name “TIME\_SERIES” is used when the series is chronological. In this case the label keywords START\_TIME and STOP\_TIME are assumed to indicate the minimum and maximum times in the file. If this is not the case, the MINIMUM\_SAMPLING\_PARAMETER and MAXIMUM\_SAMPLING\_PARAMETER keywords should be used to specify the corresponding time values for the series.

### A.24.1 Required Keywords

1. INTERCHANGE\_FORMAT
2. ROWS
3. COLUMNS
4. ROW\_BYTES
5. SAMPLING\_PARAMETER\_NAME
6. SAMPLING\_PARAMETER\_UNIT
7. SAMPLING\_PARAMETER\_INTERVAL

### A.24.2 Optional Keywords

1. NAME
2. ROW\_PREFIX\_BYTES
3. ROW\_SUFFIX\_BYTES
4. MINIMUM\_SAMPLING\_PARAMETER
5. MAXIMUM\_SAMPLING\_PARAMETER
6. DERIVED\_MINIMUM
7. DERIVED\_MAXIMUM
8. DESCRIPTION

### **A.24.3 Required Objects**

1. COLUMN

### **A.24.4 Optional Objects**

1. CONTAINER

### **A.24.5 Example**

This example illustrates the use of the SERIES object for data that vary regularly in two ways: rows of data in the SERIES occur at 60 millisecond intervals, while the column values occur at .03472222 millisecond intervals. Note that, as with other forms of the TABLE object, each row in a SERIES may contain prefix or suffix bytes, indicated in this case by the ROW\_PREFIX\_BYTES in the TIME\_SERIES definition. The structure of the prefix is defined by the ROW\_PREFIX\_TABLE object, for which the COLUMN definitions are stored in a separate file ("ROWPRX.FMT").

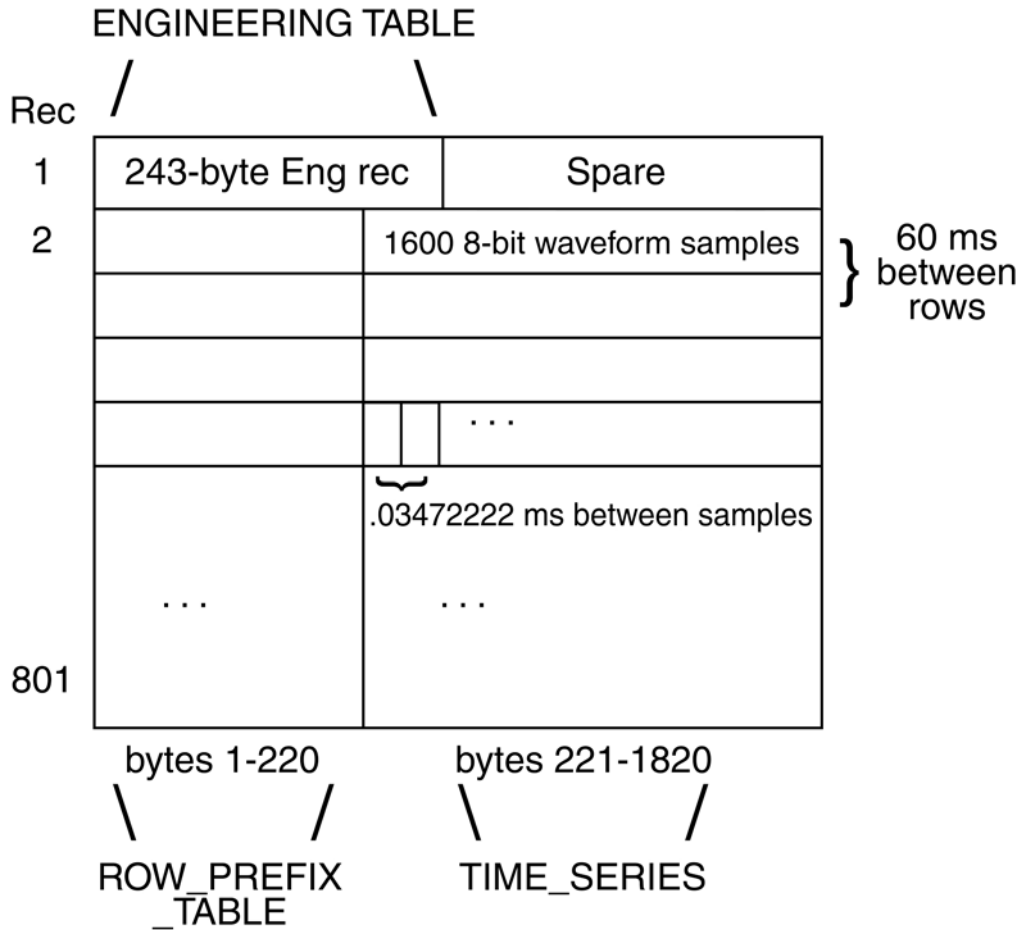

```

PDS_VERSION_ID           = PDS3
RECORD_TYPE              = FIXED_LENGTH
RECORD_BYTES             = 1820
FILE_RECORDS             = 801
^ENGINEERING_TABLE      = ("C0900313.DAT", 1)
^ROW_PREFIX_TABLE       = ("C0900313.DAT", 2)
^TIME_SERIES            = ("C0900313.DAT", 2)

/* Observation description */
DATA_SET_ID              = "VG2-N-PWS-2-EDR-WFRM-60MS-V1.0"
PRODUCT_ID              = "C0900313.DAT"
PRODUCT_CREATION_TIME   = "UNK"
SPACECRAFT_NAME         = "VOYAGER_2"
SPACECRAFT_CLOCK_START_COUNT = "09003.13.002"
SPACECRAFT_CLOCK_STOP_COUNT  = "09003.13.002"
EARTH_RECEIVED_TIME     = 1989-159T13:35:00.121
START_TIME              = 1989-157T14:16:56.979
STOP_TIME               = "N/A"
MISSION_PHASE_NAME      = "NEPTUNE_ENCOUNTER"
TARGET_NAME             = "NEPTUNE"
    
```

```

/* Instrument description */
INSTRUMENT_NAME      = PLASMA_WAVE_RECEIVER
INSTRUMENT_ID        = PWS
SECTION_ID           = WFRM

/* Object descriptions */
OBJECT                = ENGINEERING_TABLE
  INTERCHANGE_FORMAT  = BINARY
  ROWS                = 1
  COLUMNS            = 106
  ROW_BYTES           = 243
  ROW_SUFFIX_BYTES    = 1577
  DESCRIPTION         = "This table describes the format of
                        the engineering record which is included as the first record in
                        each PWS high rate waveform file.  This record contains the first
                        242 bytes of data extracted from the Mission and Test Imaging System
                        (MTIS) header record on each file of an imaging EDR tape.  A 243rd
                        byte containing some flag fields has been added to the table for all
                        data collected during the Neptune encounter."
  ^STRUCTURE          = "ENGTAB.FMT"
END_OBJECT            = ENGINEERING_TABLE

OBJECT                = ROW_PREFIX_TABLE
  INTERCHANGE_FORMAT  = BINARY
  ROWS                = 800
  COLUMNS            = 47
  ROW_BYTES           = 220
  ROW_SUFFIX_BYTES    = 1600
  DESCRIPTION         = "This table describes the format of
                        the engineering data associated with the collection of each row of
                        waveform data (1600 waveform samples)."
  ^STRUCTURE          = "ROWPRX.FMT"
END_OBJECT            = ROW_PREFIX_TABLE

OBJECT                = TIME_SERIES
  NAME                = WAVEFORM_FRAME
  INTERCHANGE_FORMAT  = BINARY
  ROWS                = 799
  COLUMNS            = 1
  ROW_BYTES           = 1600
  ROW_PREFIX_BYTES    = 220
  SAMPLING_PARAMETER_NAME = TIME
  SAMPLING_PARAMETER_UNIT   = SECOND
  SAMPLING_PARAMETER_INTERVAL = .06          /* 60 MS between rows */
  DESCRIPTION         = "This time_series consists of up to
                        800 records (or rows, lines) of PWS waveform sample data.  Each
                        record 2-801 of the file (or frame) contains 1600 waveform samples,
                        prefaced by 220 bytes of MTIS information.  The 1600 samples are
                        collected in 55.56 msec followed by a 4.44 msec gap.  Each 60 msec
                        interval constitutes a line of waveform samples.  Each file contains
                        up to 800 lines of waveform samples for a 48 sec frame."

OBJECT                = COLUMN
  NAME                = WAVEFORM_SAMPLES

```



```

DATA_TYPE                = MSB_UNSIGNED_INTEGER
START_BYTE               = 221
BYTES                    = 1600
ITEMS                    = 1600
ITEM_BYTES               = 1
SAMPLING_PARAMETER_NAME = TIME
SAMPLING_PARAMETER_UNIT = SECOND
SAMPLING_PARAMETER_INTERVAL = 0.00003472222 /*time between samples*/

OFFSET                   = -7.5
VALID_MINIMUM            = 0
VALID_MAXIMUM            = 15
DESCRIPTION               = "The 1-byte waveform samples
constitute an array of waveform measurements which are encoded into
binary values from 0 to 15 and may be re-mapped to reduce the
artificial zero-frequency component. For example, stored values can
be mapped to the following floating point values. The original 4-
bit data samples have been repackaged into 8-bit (1 byte) items
without modification for archival purposes.\n

                                0 = -7.5  1 = -6.5  2 = -5.5    3 = -4.5
                                4 = -3.5  5 = -2.5  6 = -1.5    7 = -0.5
                                8 =  0.5  9 =  1.5 10 =  2.5    11 =  3.5
                                12 =  4.5 13 =  5.5 14 =  6.5    15 =  7.5

"
END_OBJECT                = COLUMN
END_OBJECT                = TIME_SERIES

END

```

## A.25 SPECTRAL\_CUBE

### A.25.1 Introduction

Instruments classified as imaging spectrometers are increasingly being used in planetary missions. Data from these instruments are simultaneously a set of images, at different wavelengths, of the same target area, and a set of spectra at each point of the target area. In PDS archives, these data may be stored as SPECTRAL\_CUBEs, three-dimensional objects with two spatial dimensions and one spectral dimension. In these three-dimensional structures, called “cubes”, the axes have the interpretations “sample”, “line”, and “band”, respectively.

Each of the three axes in a PDS SPECTRAL\_CUBE object may optionally include suffix data that extend the length of the axis. Conceptually, this can be viewed as forming one or more Suffix planes that are attached to the Core cube, as shown in the diagram below. Suffix planes that extend the band dimension are called BACKPLANES. Suffix planes that extend the sample dimension are called SIDEPLANES. Suffix planes that extend the line dimension are called BOTTOMPLANES.

Note that these terms refer to the “logical” axes – that is, how the axes are conceptually modeled – and are not necessarily related to the physical storage of the SPECTRAL\_CUBE object. The Suffix planes are used for storing auxiliary data that are associated with the core data. For example, a backplane might be used for storing the latitude values for each spatial-spatial pixel. Another backplane might be used for storing the wavelength of the deepest absorption feature that was found in the spectrum at each spatial-spatial pixel. One or more SIDEPLANES might be used for storing engineering data that are associated with each spatial line.

### A.25.2 Logical Structure of a SPECTRAL\_CUBE

As mentioned above, the logical structure of the SPECTRAL\_CUBE is its conceptual model. This is best presented visually, as is shown in the following diagrams;

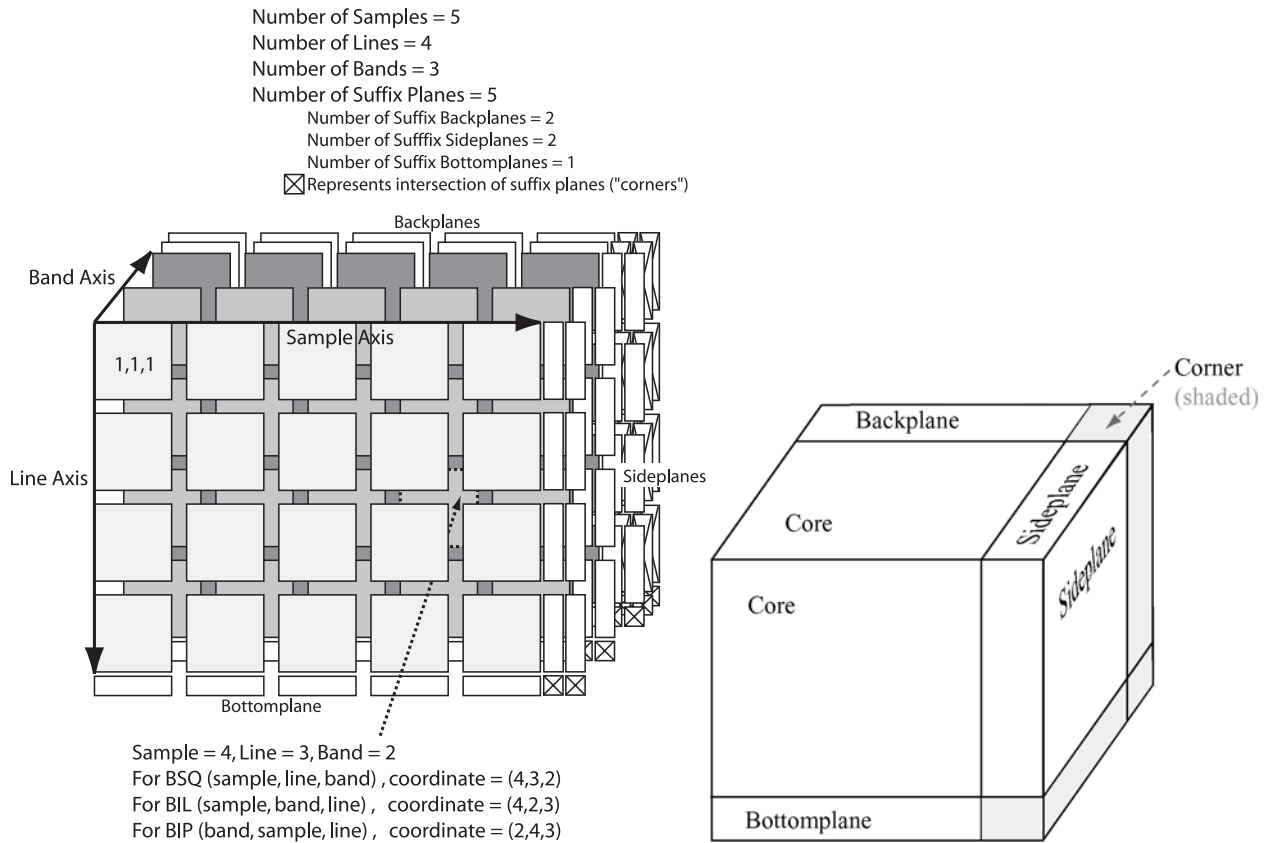

**Figure A.4 – Exploded Views of a SPECTRAL\_CUBE Object**

### A.25.2.1 Pixel Coordinates

SAMPLE=1 is the left edge of the spatial-spatial core image. LINE=1 is the top edge of the spatial-spatial core image. BAND=1 corresponds to the spatial-spatial images at the “front” of the diagram. Core coordinates do not carry over to the suffix regions.

## A.25.3 Physical Structure of a SPECTRAL\_CUBE

### A.25.3.1 Storage Orders

The file in which a PDS SPECTRAL\_CUBE data object is stored is physically accessed as though it were a one-dimensional data structure. Storing the PDS SPECTRAL\_CUBE pictured above thus requires that the “logical” three-dimensional structure be mapped into the one-dimensional physical file structure. This involves moving through the three-dimensional structure in certain patterns to determine the linear sequence of core and suffix pixel values that occur in the file. In PDS SPECTRAL\_CUBE files, this pattern is defined by specifying which

axis index varies fastest in the linear sequence of pixel values in the file, which axis varies second fastest, and which axis varies slowest.

In PDS SPECTRAL\_QUBE files, the names of the three axes are always SAMPLE, LINE, and BAND. The AXIS\_NAME keyword has an array of values that list the names of the axes in the qube. The order of the names specifies the qube storage order in the file. The first axis is the fastest varying, and the third axis is the slowest varying. The PDS SPECTRAL\_QUBE supports the following three storage orders:

- (SAMPLE, LINE, BAND) – Band Sequential (BSQ)
- (SAMPLE, BAND, LINE) – Band Interleaved by Line (BIL)
- (BAND, SAMPLE, LINE) – Band Interleaved by Pixel (BIP)

The lengths of the Core axes are given by the CORE\_ITEMS keyword, and the lengths of the Suffix axes are given by the SUFFIX\_ITEMS keyword. Both these keywords have array values, whose order corresponds to the order of the axes given by the AXIS\_NAME keyword.

In the physical file storage, Suffix pixel data (if present) are interspersed with the associated Core pixel data. For example, in a BSQ storage order file, the physical qube storage in the file begins with the pixels in the first (top) line of the spatial-spatial image plane at the first wavelength band. This is followed by the sideplane pixel values that extend this line of core pixels. Next are the core pixels for the second line, followed by the sideplane pixels for the second line. After the last line of this first core image plane (and its associated sideplane pixels) come the bottomplane pixels associated with the first band. This is then repeated for the second through last bands. Finally, all the backplane data are stored after all the core data and associated sideplane and bottomplane pixels.

If a PDS SPECTRAL\_QUBE file includes suffixes on more than one axis, then the region that is the intersection between two (or all three) of the suffix regions is called a CORNER region. The PDS requires that space for CORNER region data be allocated in the data files. However this space is never actually used.

### **A.25.3.2 Pixel Storage Sizes**

In a PDS SPECTRAL\_QUBE file, core pixels can occupy one, two, or four bytes. All core pixels within a single file must be of the same physical storage size. Suffix pixels can also occupy one, two, or four bytes of storage in the file. All the suffix pixels within a single file must be of the same physical storage size. Suffix pixels need not be the same size as core pixels. *Handling of different pixel data types is described in detail below.*

### **A.25.3.3 Core Pixel Data Types**

In PDS SPECTRAL\_CUBE files, core pixel values can be represented by one of several formats. The formats available are dependent on the number of bytes used to store the values in the file. The format is given by the CORE\_ITEM\_TYPE keyword and the number of bytes stored is given by the CORE\_ITEM\_BYTES keyword. The following table shows the allowable formats and the number of bytes of storage they use:

<b>CORE_ITEM_BYTES</b>	<b>CORE_ITEM_TYPE</b>	<b>Type Conversion Parameters</b>
1, 2, or 4	UNSIGNED_INTEGER	Yes
1, 2, or 4	MSB_UNSIGNED_INTEGER	Yes
1, 2, or 4	LSB_UNSIGNED_INTEGER	Yes
1, 2, or 4	INTEGER	Yes
1, 2, or 4	MSB_INTEGER	Yes
1, 2, or 4	LSB_INTEGER	Yes
4	IEEE_REAL	No
4	VAX_REAL	No
4	PC_REAL	No

As the table above indicates, stored integer values can be converted to real values, representing the actual pixel. The type conversion parameters are given by the CORE\_BASE and CORE\_MULTIPLIER keywords, and the real value being represented is determined as follows:

$$\text{“real\_value”} = \text{CORE\_BASE} + (\text{CORE\_MULTIPLIER} * \text{REAL}(\text{stored\_value}))$$

For 4-byte real formats, the stored values are floating point values that directly represent the pixel values.

#### **A.25.3.4 Suffix Pixel Data Types**

The same data types and number of storage bytes that are shown in the above table are also available to Suffix pixels. However, Suffix pixels need not be the same size or have the same data type as the Core pixels. Therefore, there is a SUFFIX\_ITEM\_BYTES keyword to indicate the number of bytes stored for Suffix pixels and a SUFFIX\_ITEM\_TYPE keyword to describe the data type of the Suffix pixels. Each suffix plane within a single file can have a different data format. Thus, the values of these keywords are arrays. Each element of the array refers to a separate suffix plane.

#### **A.25.3.5 Aligning Suffix Pixels within Allocated Bytes**

The SPECTRAL\_CUBE allows the number of bytes used to store data in each Suffix pixel (SUFFIX\_ITEM\_BYTES) to be less than the total number of bytes allocated to each Suffix pixel (SUFFIX\_BYTES). It is therefore necessary to describe how the stored bytes are aligned within the allocated bytes. The BIT\_MASK keyword is used for this purpose.

#### **A.25.4 Data Dictionary Elements for the SPECTRAL\_CUBE**

The following section details the required and optional data dictionary elements that comprise the SPECTRAL\_CUBE.

NOTE: Some of the following required and optional elements of the SPECTRAL\_CUBE object are ISIS-specific. Since the ISIS system was designed before the current version of the Planetary Science Data Dictionary, some of the element names below conflict with current PDS nomenclature standards.

### A.25.4.1 Required Objects

None.

### A.25.4.2 Optional Objects

Object Name	Definition
IMAGE_MAP_PROJECTION	Map projection information for the image planes.

### A.25.4.3 Required Groups

Group Name	Definition
BAND_BIN	Group describing properties of each "bin" along the spectral axis.

### A.25.4.4 Optional Groups

The following groups are optional, in that they describe optional Suffix axes. However, if the named axis does appear, its descriptive keywords must be part of the appropriate group:

Group Name	Definition
BAND_SUFFIX	Group describing properties of the BAND Suffix plane ("BACKPLANE").
LINE_SUFFIX	Group describing properties of the LINE Suffix plane ("BOTTOMPLANE").
SAMPLE_SUFFIX	Group describing properties of the SAMPLE Suffix plane ("SIDEPLANE").

### A.25.4.5 Required Keywords – Outside of Groups

Keyword Name	Definition	Values
AXES	Number of axes or dimensions of SPECTRAL_CUBE	3 (SPECTRAL_CUBEs are 3-dimensional by definition).
AXIS_NAME	Names of axes in order of physical storage.	Literal values SAMPLE, LINE, and BAND in storage order. One of these three storage orders is required:  (SAMPLE, LINE, BAND) (BAND, SAMPLE, LINE) (SAMPLE, BAND, LINE).
CORE_ITEMS	Number of pixels on each axis of the Core, in the same order as in AXIS_NAME	Sequence of three integers, e.g. (256, 512, 3).
CORE_ITEM_BYTES	Number of bytes in each core pixel.	1, 2, or 4.
CORE_ITEM_TYPE	Data type of core pixels.	UNSIGNED_INTEGER, MSB_UNSIGNED_INTEGER, LSB_UNSIGNED_INTEGER, INTEGER, MSB_INTEGER, LSB_INTEGER, IEEE_REAL, VAX_REAL, PC_REAL.
SUFFIX_ITEMS	Number of side (SAMPLE) suffix planes, bottom (LINE) suffix planes, and back (BAND) suffix planes, in same order as in AXIS_NAME.	Sequence of three integers. If there are no suffix planes, the value is (0, 0, 0).
<b>If suffix planes are present:</b>		
SUFFIX_BYTES	Number of bytes allocated for each suffix pixel.	1, 2, or 4. See also SUFFIX_ITEM_BYTES.

### A.25.4.6 Required Keywords – In the \*\_SUFFIX Groups

If there are SUFFIX planes, then the following keywords are required. In order to avoid having to create up to three instances of each one (e.g., BAND\_SUFFIX\_NAME, LINE\_SUFFIX\_NAME, and SAMPLE\_SUFFIX\_NAME), the keywords must be nested in the appropriate group (see section on Optional Groups):

BAND\_SUFFIX group – if describing a BAND SUFFIX  
 LINE\_SUFFIX group – if describing a LINE SUFFIX



SAMPLE\_SUFFIX group – if describing a SAMPLE SUFFIX

Keyword Name	Definition	Values
SUFFIX_NAME	Name of suffix plane	Literal, e.g. LATITUDE
SUFFIX_ITEM_BYTES	Number of bytes used to store data in each suffix pixel; may be less than the number of bytes allocated for each pixel.	1, 2, or 4. See also SUFFIX_BYTES.
SUFFIX_ITEM_TYPE	Data type of suffix pixels.	UNSIGNED_INTEGER, MSB_UNSIGNED_INTEGER, LSB_UNSIGNED_INTEGER, INTEGER, MSB_INTEGER, LSB_INTEGER, IEEE_REAL, VAX_REAL, PC_REAL.

#### A.25.4.7 Required Keywords – In the BAND\_BIN Group

Keyword Name	Definition	Values
BANDS	Number of bands in SPECTRAL_QUBE (same as given for the BAND axis in CORE_ITEMS, repeated here for convenience).	Integer.
BAND_BIN_CENTER	Wavelengths or frequencies at band centers.	Sequence of real values, one per band.
BAND_BIN_UNIT	Unit of measurement of BAND_BIN_CENTER and BAND_BIN_WIDTH values.	For example, MICROMETER.
BAND_BIN_WIDTH	Widths (at half height) of bands.	Sequence of real values, one per band.

**Note:** In the case where there are so many bands that the BAND\_BIN group becomes cumbersome in the label, it may be stored in a separate file indicated in the label by a structure pointer, e.g. ^STRUCTURE = "BAND\_BIN.FMT".

#### A.25.4.8 Optional Keywords

The following keywords are optional for the PDS SPECTRAL\_QUBE. Some of these keywords must be used if the SPECTRAL\_QUBE is designed for use with the Integrated Software for Imagers and Spectrometers (ISIS). The column labeled ISIS indicates whether the keyword is

required by ISIS software. A “YES” means the keyword is required by ISIS, while a “NO” means it is not:

Keyword Name	Definition	Values	ISIS
ISIS_STRUCTURE_VERSION	Version of ISIS software with which the SPECTRAL_CUBE's physical structure is compatible.	2.1 (Only current valid version number)	YES
CORE_NAME	Name of data value stored in the SPECTRAL_CUBE	Literal, e.g. SPECTRAL_RADIANCE.	YES
CORE_BASE	Base value for scaling core pixels.	Real.	YES
CORE_MULTIPLIER	Multiplier for scaling core pixels.	Real.	YES
CORE_UNIT	Unit of measurement of core data values.	For example, “WATT*M**2*SR**-1*mM**-1” (for spectral radiance) or ‘DIMENSIONLESS’ (for raw data).	YES
CORE_VALID_MINIMUM	Minimum valid core value.	Values below CORE_VALID_MINIMUM have special meaning.	YES
CORE_NULL	Special value that indicates invalid data.	Must be less than CORE_VALID_MINIMUM.	YES
CORE_LOW_REPR_SATURATION	Special value that indicates representation saturation at low end.	Must be less than CORE_VALID_MINIMUM.	YES
CORE_LOW_INSTR_SATURATION	Special value that indicates instrument saturation at low end.	Must be less than CORE_VALID_MINIMUM.	YES
CORE_HIGH_REPR_SATURATION	Special value that indicates representation saturation at high end.	Must be less than CORE_VALID_MINIMUM.	YES
CORE_HIGH_INSTR_SATURATION	Special value that indicates instrument saturation at high end.	Must be less than CORE_VALID_MINIMUM.	YES
SUFFIX_BYTES	Number of bytes allocated for each suffix pixel (required even if no suffix planes are present).	1, 2, or 4. See also SUFFIX_ITEM_BYTES.	YES
MD5_CHECKSUM	MD5 checksum of all core and suffix bytes.	Character String.	NO
LINE_DISPLAY_DIRECTION	The preferred orientation of lines within an image for	DOWN, UP, LEFT, RIGHT.	NO

	viewing on a display device. The default value is down, where lines are viewed top to bottom on the display.		
SAMPLE_DISPLAY_DIRECTION	The preferred orientation of samples within a line for viewing on a display device. The default is right, meaning samples are viewed from left to right on the display.	DOWN, UP, LEFT, RIGHT.	NO
<b>In BAND_SUFFIX, LINE_SUFFIX, and SAMPLE_SUFFIX groups:</b>			
BIT_MASK	A series of binary digits defining the active bits in a value. Required when fewer bytes are used than are allocated.	A sequence of bits equal to the bit-length of the allocated storage.	NO
SUFFIX_BASE	Base value for scaling suffix pixels.	Real.	NO
SUFFIX_MULTIPLIER	Multiplier for scaling suffix pixels.	Real.	NO
SUFFIX_VALID_MINIMUM	Minimum valid suffix value.	Values below SUFFIX_VALID_MINIMUM have special meaning.	NO
SUFFIX_NULL	Special value that indicates invalid data.	Must be less than SUFFIX_VALID_MINIMUM.	NO
SUFFIX_LOW_REPR_SAT	Special value that indicates representation saturation at low end.	Must be less than SUFFIX_VALID_MINIMUM.	NO
SUFFIX_LOW_INSTR_SAT	Special value that indicates instrument saturation at low end.	Must be less than SUFFIX_VALID_MINIMUM.	NO
SUFFIX_HIGH_REPR_SAT	Special value that indicates representation saturation at high end.	Must be less than SUFFIX_VALID_MINIMUM.	NO
SUFFIX_HIGH_INSTR_SAT	Special value that indicates instrument saturation at high end.	Must be less than SUFFIX_VALID_MINIMUM.	NO
SUFFIX_UNIT	Unit of measurement of suffix data values.	For example, 'DEGREE', 'DIMENSIONLESS'.	NO
<b>In BAND_BIN group:</b>			
BAND_BIN_STANDARD_DEVIATION	Standard deviations of spectrometer values at each band.	Sequence of real values, one per band.	NO

BAND_BIN_DETECTOR	Instrument detector number of each band, where relevant.	Sequence of integers, one per band.	NO
BAND_BIN_GRATING_POSITION	Instrument grating position of each band, where relevant.	Sequence of integers, one per band.	NO
BAND_BIN_ORIGINAL_BAND	Where relevant, band numbers from the original qube of which the current qube is a subset. Band numbers in the original qube are sequential integers.	Sequence of integers, one per band, listed in storage order for the current qube.	NO
BAND_BIN_BAND_NUMBER	List of band numbers corresponding to each band contained in the image. The band number is equivalent to the instrument band number.	Sequence of integers, one per band.	NO
BAND_BIN_FILTER_NUMBER	List of filter numbers corresponding to each band contained in the image. The filter number describes the physical location of the band in the detector array. Filter 1 is on the leading edge of the array.	Sequence of integers, one per band.	NO
BAND_BIN_BASE	The offset value for the stored data of each band listed in the BAND_BIN_BAND_NUMBER. The BAND_BIN_BASE value is added to the scaled data (see BAND_BIN_MULTIPLIER) to reproduce the true data.	Sequence of real values, one per band.	NO
BAND_BIN_MULTIPLIER	The constant value by which the stored data of each band listed in the BAND_BIN_BAND_NUMBER is multiplied to produce the scaled data; the BAND_BIN_BASE value is added to the scaled data to reproduce the true data.	Sequence of real values, one per band.	NO

### A.25.5 Example label for a PDS SPECTRAL\_QUBE

```

PDS_VERSION_ID                = PDS3

/* File Identification and Structure */

RECORD_TYPE                    = FIXED_LENGTH
RECORD_BYTES                   = 644
FILE_RECORDS                   = 249888

/* Pointer to Data Object */

^SPECTRAL_QUBE                 = "SAMPLE1.QUB"

/* Identification Data Elements */

DATA_SET_ID                    =
PRODUCT_ID                     =
INSTRUMENT_HOST_NAME           =
INSTRUMENT_NAME                =
TARGET_NAME                    =
START_TIME                     =
STOP_TIME                      =
SPACECRAFT_CLOCK_START_COUNT   =
SPACECRAFT_CLOCK_STOP_COUNT    =
PRODUCT_CREATION_TIME          =

/* SPECTRAL_QUBE Object Description */

OBJECT                         = SPECTRAL_QUBE

  AXES                          = 3
  AXIS_NAME                     = (SAMPLE, LINE, BAND)
  ISIS_STRUCTURE_VERSION        = "N/A"
  MD5_CHECKSUM                  = cf65a98aff4232f5ac5171406590a932

/* Core Description */

CORE_ITEMS                     = (320, 272, 224)
CORE_NAME                      = "CALIBRATED SPECTRAL RADIANCE"
CORE_ITEM_BYTES                = 2
CORE_ITEM_TYPE                 = MSB_INTEGER
CORE_BASE                      = 0.000000
CORE_MULTIPLIER                = 1.000000
CORE_UNIT                      = "WATT*CM**-2*SR**-1*UM**-1"
CORE_NULL                      = -32768
CORE_VALID_MINIMUM             = -32752
CORE_LOW_REPR_SATURATION       = -32767
CORE_LOW_INSTR_SATURATION      = -32766
CORE_HIGH_REPR_SATURATION      = -32765
CORE_HIGH_INSTR_SATURATION     = -32764

```

```

/* Suffix Descriptions */

SUFFIX_ITEMS           = (1, 1, 2)
SUFFIX_BYTES          = 4

GROUP                  = SAMPLE_SUFFIX
  SUFFIX_NAME          = HORIZONTAL_DESTRIPE
  SUFFIX_ITEM_BYTES    = 4
  SUFFIX_ITEM_TYPE     = IEEE_REAL
  SUFFIX_BASE          = 0.000000
  SUFFIX_MULTIPLIER    = 1.000000
  SUFFIX_VALID_MINIMUM = 16#FFFFFFFF#
  SUFFIX_NULL          = 16#FFFFFFFF#
  SUFFIX_LOW_REPR_SAT  = 16#FFFFFFFF#
  SUFFIX_LOW_INSTR_SAT = 16#FFFDFFFF#
  SUFFIX_HIGH_REPR_SAT = 16#FFFBFFFF#
  SUFFIX_HIGH_INSTR_SAT = 16#FFFCFFFF#
END_GROUP

GROUP                  = LINE_SUFFIX
  SUFFIX_NAME          = VERTICAL_DESTRIPE
  SUFFIX_ITEM_BYTES    = 4
  SUFFIX_ITEM_TYPE     = IEEE_REAL
  SUFFIX_BASE          = 0.000000
  SUFFIX_MULTIPLIER    = 1.000000
  SUFFIX_VALID_MINIMUM = 16#FFFFFFFF#
  SUFFIX_NULL          = 16#FFFFFFFF#
  SUFFIX_LOW_REPR_SAT  = 16#FFFFFFFF#
  SUFFIX_LOW_INSTR_SAT = 16#FFFDFFFF#
  SUFFIX_HIGH_REPR_SAT = 16#FFFBFFFF#
  SUFFIX_HIGH_INSTR_SAT = 16#FFFCFFFF#
END_GROUP

GROUP                  = BAND_SUFFIX
  SUFFIX_NAME          = (LATITUDE, LONGITUDE)
  SUFFIX_UNIT          = (DEGREE, DEGREE)
  SUFFIX_ITEM_BYTES    = (4, 4)
  SUFFIX_ITEM_TYPE     = (IEEE_REAL, IEEE_REAL)
  SUFFIX_BASE          = (0.000000, 0.000000)
  SUFFIX_MULTIPLIER    = (1.000000, 1.000000)
END_GROUP

/* Band bin information */
/* For this example with 224 bands: */
/* The BAND_BIN group is stored in a separate file. */

^STRUCTURE             = "BAND_BIN.FMT"

/* Map projection information */

OBJECT                 = IMAGE_MAP_PROJECTION
  A_AXIS_RADIUS        = 1737.400000
  B_AXIS_RADIUS        = 1737.400000
  C_AXIS_RADIUS        = 1737.400000

```

```

    POSITIVE_LONGITUDE_DIRECTION = EAST
    MAP_PROJECTION_TYPE           = "SINUSOIDAL EQUAL AREA"
    MAP_SCALE                     = 0.1000000
    MAP_RESOLUTION                = 303.2334900
    EASTERNMOST_LONGITUDE        = 126.0177002
    WESTERNMOST_LONGITUDE        = 120.0000000
    MINIMUM_LATITUDE             = 20.9867992
    MAXIMUM_LATITUDE             = 28.0000000
    CENTER_LONGITUDE             = 135.0000000
    REFERENCE_LATITUDE           = 0.0000000
    REFERENCE_LONGITUDE          = 0.0000000
    MAP_PROJECTION_ROTATION       = 0.0000000
    LINE_PROJECTION_OFFSET        = -8490.0381188
    SAMPLE_PROJECTION_OFFSET      = -4246.2684059
    END_OBJECT                    = IMAGE_MAP_PROJECTION

    END_OBJECT                    = SPECTRAL_CUBE

    END

```

### A.25.6 Contents of Example BAND\_BIN.FMT

```

GROUP = BAND_BIN
  BANDS = 224
  BAND_BIN_UNIT = MICROMETER
  BAND_BIN_CENTER = (
0.374370, 0.384460, 0.394120, 0.403770, 0.413430, 0.423090, 0.432750,
0.442420, 0.452080, 0.461750, 0.471410, 0.481080, 0.490750, 0.500410,
0.510080, 0.519760, 0.529430, 0.539100, 0.548780, 0.558450, 0.568130,
0.577810, 0.587490, 0.597170, 0.606850, 0.616530, 0.626210, 0.635900,
0.645580, 0.655270, 0.664960, 0.674630, 0.684300, 0.693980, 0.703660,
0.713340, 0.723020, 0.732700, 0.742380, 0.752060, 0.761740, 0.771420,
0.781100, 0.790780, 0.800460, 0.810140, 0.819820, 0.829500, 0.839180,
0.848860, 0.858540, 0.868220, 0.877900, 0.887580, 0.897260, 0.906940,
0.916620, 0.926300, 0.935980, 0.945660, 0.955340, 0.965020, 0.974700,
0.984380, 0.994060, 1.003740, 1.013420, 1.023100, 1.032780, 1.042460,
1.052140, 1.061820, 1.071500, 1.081180, 1.090860, 1.100540, 1.110220,
1.119900, 1.129580, 1.139260, 1.148940, 1.158620, 1.168300, 1.177980,
1.187660, 1.197340, 1.207020, 1.216700, 1.226380, 1.236060, 1.245740,
1.255420, 1.265100, 1.274780, 1.284460, 1.294140, 1.303820, 1.313500,
1.323180, 1.332860, 1.342540, 1.352220, 1.361900, 1.371580, 1.381260,
1.390940, 1.400620, 1.410300, 1.420000, 1.429700, 1.439400, 1.449100,
1.458800, 1.468500, 1.478200, 1.487900, 1.497600, 1.507300, 1.517000,
1.526700, 1.536400, 1.546100, 1.555800, 1.565500, 1.575200, 1.584900,
1.594600, 1.604300, 1.614000, 1.623700, 1.633400, 1.643100, 1.652800,
1.662500, 1.672200, 1.681900, 1.691600, 1.701300, 1.711000, 1.720700,
1.730400, 1.740100, 1.749800, 1.759500, 1.769200, 1.778900, 1.788600,
1.798300, 1.808000, 1.817700, 1.827400, 1.837100, 1.846800, 1.856500,
1.866200, 1.875900, 1.885600, 1.895300, 1.905000, 1.914700, 1.924400,
1.934100, 1.943800, 1.953500, 1.963200, 1.972900, 1.982600, 1.992300,
2.002000, 2.011700, 2.021400, 2.031100, 2.040800, 2.050500, 2.060200,
2.069900, 2.079600, 2.089300, 2.099000, 2.108700, 2.118400, 2.128100,
2.137800, 2.147500, 2.157200, 2.166900,

```

```

2.170920, 2.180900, 2.190880, 2.200860, 2.210830, 2.220810, 2.230770,
2.240740, 2.250700, 2.260660, 2.270620, 2.280580, 2.290530, 2.300480,
2.310430, 2.320370, 2.330320, 2.340260, 3.250190, 2.360130, 2.370060,
2.379990, 2.389920, 2.399840, 2.409760, 2.419680, 2.429600, 2.439510,
2.449420, 2.459330, 2.469240, 2.479140, 2.489040, 2.498940, 2.508830)

```

```

BAND_BIN_WIDTH = (
0.015450, 0.011530, 0.011380, 0.011230, 0.011090, 0.010960, 0.010830,
0.010710, 0.010590, 0.010490, 0.010380, 0.010290, 0.010200, 0.010120,
0.010040, 0.009970, 0.009910, 0.009850, 0.009800, 0.009760, 0.009720,
0.009690, 0.009660, 0.009640, 0.009630, 0.009630, 0.009630, 0.009640,
0.009650, 0.009670, 0.009700, 0.012670, 0.010880, 0.009560, 0.009520,
0.009500, 0.009480, 0.009470, 0.009470, 0.009470, 0.009490, 0.009510,
0.009540, 0.009580, 0.009620, 0.009680, 0.009740, 0.009810, 0.009890,
0.009970, 0.010070, 0.010170, 0.010280, 0.010390, 0.010520, 0.010650,
0.010790, 0.010940, 0.011100, 0.011260, 0.011440, 0.010160, 0.009210,
0.009790, 0.009440, 0.009440, 0.009430, 0.009420, 0.009410, 0.009410,
0.009400, 0.009400, 0.009390, 0.009390, 0.009380, 0.009380, 0.009380,
0.009380, 0.009380, 0.009380, 0.009380, 0.009380, 0.009380, 0.009380,
0.009390, 0.009390, 0.009390, 0.009400, 0.009410, 0.009410, 0.009420,
0.009430, 0.009430, 0.009440, 0.009450, 0.010090, 0.011130, 0.011140,
0.011150, 0.011150, 0.011160, 0.011160, 0.011170, 0.011170, 0.011180,
0.011180, 0.011180, 0.011190, 0.011190, 0.011190, 0.011190, 0.011190,
0.011200, 0.011200, 0.011200, 0.011200, 0.011200, 0.011190, 0.011190,
0.011190, 0.011190, 0.011190, 0.011180, 0.011180, 0.011180, 0.011170,
0.011170, 0.011160, 0.011160, 0.011150, 0.011140, 0.011140, 0.011130,
0.011120, 0.011110, 0.011110, 0.011100, 0.011090, 0.011080, 0.011070,
0.011060, 0.011050, 0.011040, 0.011030, 0.011010, 0.011000, 0.010990,
0.010980, 0.010960, 0.010950, 0.010930, 0.010920, 0.010910, 0.010890,
0.010870, 0.010860, 0.010840, 0.010820, 0.010810, 0.010790, 0.009980,
0.009970, 0.009950, 0.009940, 0.009930, 0.009910, 0.009900, 0.009890,
0.009880, 0.009860, 0.009850, 0.009840, 0.009820, 0.009810, 0.009800,
0.009790, 0.009770, 0.009760, 0.009750, 0.009730, 0.009720, 0.009710,
0.009700, 0.009680, 0.009670, 0.009660, 0.009650, 0.009630, 0.009620,
0.009610, 0.009600, 0.009580, 0.009570, 0.009560, 0.009550, 0.009530,
0.009520, 0.009510, 0.009500, 0.009490, 0.009470, 0.009460, 0.009450,
0.009440, 0.009420, 0.009410, 0.009400, 0.009390, 0.009380, 0.009360,
0.009350, 0.009340, 0.009330, 0.009320, 0.009300, 0.009290, 0.009280,
0.009270, 0.009260, 0.009250, 0.009230, 0.009220, 0.009210, 0.009200)

```

```

END_GROUP = BAND_BIN

```

### A.25.7 Note on Using PDS SPECTRAL\_QUBEs with ISIS Software

The Integrated Software for Imagers and Spectrometers (ISIS) system, developed by the U.S. Geological Survey, uses image qubes as its principal data structure. The PDS SPECTRAL\_QUBE may be designed in such a way as to be suitable for use with ISIS. The optional keyword ISIS\_STRUCTURE\_VERSION is used to indicate that the SPECTRAL\_QUBE is to be used with ISIS. As of this writing, “2.1” is the only valid ISIS version that can be used for this keyword:





```

STOP_TIME =
SPACECRAFT_CLOCK_START_COUNT =
SPACECRAFT_CLOCK_STOP_COUNT =
PRODUCT_CREATION_TIME =

/* SPECTRAL_CUBE Object Description */

OBJECT = SPECTRAL_CUBE

  AXES = 3
  AXIS_NAME = (SAMPLE, LINE, BAND)
  ISIS_STRUCTURE_VERSION = "2.1"
  MD5_CHECKSUM = cf65a98aff4232f5ac5171406590a929

/* Core Description */

CORE_ITEMS = (320, 272, 3)
CORE_NAME = "CALIBRATED SPECTRAL RADIANCE"
CORE_ITEM_BYTES = 2
CORE_ITEM_TYPE = MSB_INTEGER
CORE_BASE = 0.000000
CORE_MULTIPLIER = 1.000000
CORE_UNIT = "WATT*CM**-2*SR**-1*UM**-1"
CORE_NULL = -32768
CORE_VALID_MINIMUM = -32752
CORE_LOW_REPR_SATURATION = -32767
CORE_LOW_INSTR_SATURATION = -32766
CORE_HIGH_REPR_SATURATION = -32765
CORE_HIGH_INSTR_SATURATION = -32764

/* Suffix Descriptions */

SUFFIX_ITEMS = (1, 1, 2)
SUFFIX_BYTES = 4

GROUP = SAMPLE_SUFFIX
  SUFFIX_NAME = HORIZONTAL_DESTRIPE
  SUFFIX_ITEM_BYTES = 4
  SUFFIX_ITEM_TYPE = IEEE_REAL
  SUFFIX_BASE = 0.000000
  SUFFIX_MULTIPLIER = 1.000000
  SUFFIX_VALID_MINIMUM = 16#FFFEFFFFFF#
  SUFFIX_NULL = 16#FFFFFFF#
  SUFFIX_LOW_REPR_SAT = 16#FFFEFFFFFF#
  SUFFIX_LOW_INSTR_SAT = 16#FFFDFFFF#
  SUFFIX_HIGH_REPR_SAT = 16#FFFBFFFF#
  SUFFIX_HIGH_INSTR_SAT = 16#FFFCFFFF#
END_GROUP

GROUP = LINE_SUFFIX
  SUFFIX_NAME = VERTICAL_DESTRIPE
  SUFFIX_ITEM_BYTES = 4
  SUFFIX_ITEM_TYPE = IEEE_REAL
  SUFFIX_BASE = 0.000000

```

```

    SUFFIX_MULTIPLIER           = 1.000000
    SUFFIX_VALID_MINIMUM       = 16#FFFFFFFF#
    SUFFIX_NULL                 = 16#FFFFFFFF#
    SUFFIX_LOW_REPR_SAT        = 16#FFFFFFFF#
    SUFFIX_LOW_INSTR_SAT       = 16#FFFDFFFF#
    SUFFIX_HIGH_REPR_SAT       = 16#FFFBFFFF#
    SUFFIX_HIGH_INSTR_SAT      = 16#FFFCFFFF#
END_GROUP                     = LINE_SUFFIX

GROUP                          = BAND_SUFFIX
    SUFFIX_NAME                 = (LATITUDE, LONGITUDE)
    SUFFIX_UNIT                 = (DEGREE, DEGREE)
    SUFFIX_ITEM_BYTES          = (4, 4)
    SUFFIX_ITEM_TYPE           = (IEEE_REAL, IEEE_REAL)
    SUFFIX_BASE                 = (0.000000, 0.000000)
    SUFFIX_MULTIPLIER          = (1.000000, 1.000000)
END_GROUP                     = BAND_SUFFIX

/* Band bin information */

GROUP                          = BAND_BIN
    BANDS                      = 3
    BAND_BIN_UNIT              = MICROMETER
    BAND_BIN_FILTER_NUMBER     = (1, 2, 3)
    BAND_BIN_BAND_NUMBER      = (2, 3, 4)
    BAND_BIN_CENTER            = (6.78, 9.35, 14.88)
    BAND_BIN_WIDTH             = (1.01, 1.20, 0.87)
    BAND_BIN_BASE              = (0.0, 0.0, 0.0)
    BAND_BIN_MULTIPLIER        = (1.0, 1.0, 1.0)
END_GROUP                     = BAND_BIN

/* Map projection information */

OBJECT                          = IMAGE_MAP_PROJECTION
    A_AXIS_RADIUS              = 1737.4000000
    B_AXIS_RADIUS              = 1737.4000000
    C_AXIS_RADIUS              = 1737.4000000
    POSITIVE_LONGITUDE_DIRECTION = EAST
    MAP_PROJECTION_TYPE        = "SINUSOIDAL EQUAL AREA"
    MAP_SCALE                   = 0.1000000
    MAP_RESOLUTION              = 303.2334900
    EASTERNMOST_LONGITUDE      = 126.0177002
    WESTERNMOST_LONGITUDE      = 120.0000000
    MINIMUM_LATITUDE           = 20.9867992
    MAXIMUM_LATITUDE           = 28.0000000
    CENTER_LONGITUDE           = 135.0000000
    REFERENCE_LATITUDE          = 0.0000000
    REFERENCE_LONGITUDE        = 0.0000000
    MAP_PROJECTION_ROTATION     = 0.0000000
    LINE_PROJECTION_OFFSET      = -8490.0381188
    SAMPLE_PROJECTION_OFFSET    = -4246.2684059
END_OBJECT                    = IMAGE_MAP_PROJECTION

END_OBJECT                    = SPECTRAL_CUBE

```

END

## A.26 SPECTRUM

The SPECTRUM object is a form of TABLE used for storing spectral measurements. The SPECTRUM object is assumed to have a number of measurements of the observation target taken in different spectral bands. The SPECTRUM object uses the same physical format specification as the TABLE object, but includes sampling parameter definitions which indicate the spectral region measured in successive COLUMNS or ROWS. The common sampling parameters for SPECTRUM objects are wavelength, frequency, or velocity.

A regularly sampled SPECTRUM can be stored either horizontally as a one-row table with a single column containing  $n$  samples (indicated in the COLUMN definition by “ITEMS =  $n$ ”), or vertically as a one-column table with  $n$  rows where each row contains a sample of the spectrum. The vertical format allows additional columns to be defined for related parameters for each sample value (e.g., error bars). These related columns may also be described in a separate PREFIX or SUFFIX table.

In the horizontal format, the sampling parameter specifications are included in the COLUMN definition. For a vertically defined SPECTRUM, the sampling parameter information is provided in the SPECTRUM object, since it is describing the spectral variation between the rows of the data. An irregularly sampled SPECTRUM must be stored horizontally, with each specific spectral range identified as a separate column.

### A.26.1 Required Keywords

1. INTERCHANGE\_FORMAT
2. ROWS
3. COLUMNS
4. ROW\_BYTES

### A.26.2 Optional Keywords

1. NAME
2. SAMPLING\_PARAMETER\_NAME
3. SAMPLING\_PARAMETER\_UNIT
4. SAMPLING\_PARAMETER\_INTERVAL
5. ROW\_PREFIX\_BYTES
6. ROW\_SUFFIX\_BYTES
7. MINIMUM\_SAMPLING\_PARAMETER
8. MAXIMUM\_SAMPLING\_PARAMETER
9. DERIVED\_MINIMUM
10. DERIVED\_MAXIMUM
11. DESCRIPTION

### A.26.3 Required Objects

#### 1. COLUMN

### A.26.4 Optional Objects

#### 1. CONTAINER

### A.26.5 Example

This example illustrates a SPECTRUM data object stored in a vertical format. The data are regularly sampled at intervals of 99.09618 meters/second and data samples are stored in successive ROWS.

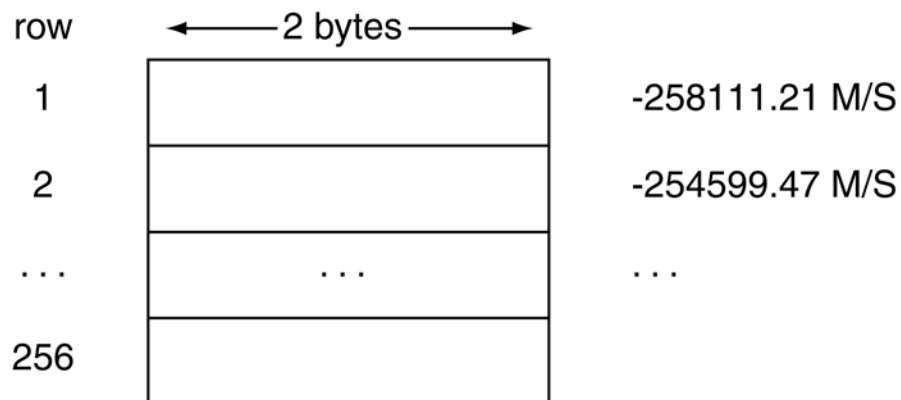

```

PDS_VERSION_ID          = PDS3
RECORD_TYPE             = FIXED_LENGTH
RECORD_BYTES           = 2
FILE_RECORDS           = 256
PRODUCT_ID             = "RSSL007.DAT"
DATA_SET_ID            = "IHW-C-RSSL-3-EDR-HALLEY-V1.0"
TARGET_NAME            = "HALLEY"
INSTRUMENT_HOST_NAME   = "IHW RADIO STUDIES NETWORK"
INSTRUMENT_NAME        = "RADIO SPECTRAL LINE DATA"
OBSERVATION_ID         = "621270"
START_TIME             = 1985-11-10T00:43:12.000
STOP_TIME              = 1985-11-10T00:43:12.000
PRODUCT_CREATION_TIME  = "UNK"

```

```

/* Record Pointer to Major Object */
^TOTAL_INTENSITY_SPECTRUM = "RSSL0007.DAT"

```

```

/* Object Description */

```

```

OBJECT                  = SPECTRUM
INTERCHANGE_FORMAT     = BINARY

```

```
ROWS = 256
ROW_BYTES = 2
COLUMNS = 1
SAMPLING_PARAMETER_NAME = "VELO_COM"
MINIMUM_SAMPLING_PARAMETER = -1.268431E+04
SAMPLING_PARAMETER_INTERVAL = 9.909618E+01
SAMPLING_PARAMETER_UNIT = "METERS/SECOND"
DESCRIPTION = "Radio Studies; Spectral Line intensity
              spectrum. Spectrum is organized as 1
              column with 256 rows. Each row
              contains a spectral value for the
              velocity derived from the sampling
              parameter information associated with
              each row."

OBJECT = COLUMN
  NAME = FLUX_DENSITY
  DATA_TYPE = MSB_INTEGER
  START_BYTE = 1
  BYTES = 2
  SCALING_FACTOR = 7.251200E-04
  OFFSET = 0.000000E+01
  DERIVED_MINIMUM = 2.380000E+01
  DERIVED_MAXIMUM = 3.490000E+01
END_OBJECT = COLUMN
END_OBJECT = SPECTRUM

END
```

## A.27 SPICE KERNEL

The SPICE\_KERNEL object describes a single kernel file in a collection of SPICE kernels. SPICE kernels provide ancillary data needed to support the planning and subsequent analysis of space science observations. The SPICE system includes the software and documentation required to read the SPICE Kernels and use the data contained therein to help plan observations or interpret space science data. This software and associated documentation are collectively called the NAIF Toolkit.

Kernel files are the major components of the SPICE system. Each type of kernel, indicated by the KERNEL\_TYPE keyword, corresponds to one of these components and has a specific abbreviation. The major kernel types, their abbreviations, and the associated file extension(s) are listed in the following table. (For a complete list of file extensions, see Section 10.2.3.)

<b>KERNEL_TYPE</b>	<b>Abbreviation</b>	<b>File Extension</b>	<b>Contents</b>
EPHEMERIS	SPK	.BSP – <i>binary</i> .XSP – <i>transfer</i>	Spacecraft, planet, satellite, or other target body ephemeris data to provide position and velocity of a target as a function of time
TARGET_CONSTANTS	PCK	.TPC	Cartographic constants for a planet, satellite, comet, or asteroid
INSTRUMENT	IK	.TI	Collected science instrument information, including specification of the mounting alignment, internal timing, and other information needed to interpret measurements made with a particular instrument
POINTING	CK	.BC – <i>binary</i> .XC – <i>transfer</i>	Pointing data, e.g., the inertially referenced attitude for a spacecraft structure upon which instruments are mounted, given as a function of time
EVENTS	EK	.XES	Event information, e.g., spacecraft and instrument commands, ground data system event logs, and experimenter's notebook comments
LEAPSECONDS	LSK	.TLS	An account of the leapseconds needed to correlate civil time (UTC) to ephemeris time (TDB), the measure of time used in the SP kernel files
SPACECRAFT_CLOCK- _COEFFICIENTS	SCLK	.TSC	Data needed to correlate a spacecraft clock to ephemeris time

Data products referencing a particular SPICE kernel do so by including the SOURCE\_PRODUCT\_ID keyword in their label with a value corresponding to that of the PRODUCT\_ID keyword in the SPICE\_KERNEL label. (The PRODUCT\_ID keyword is unique to a data product.)



### A.27.1 Required Keywords

1. DESCRIPTION
2. INTERCHANGE\_FORMAT
3. KERNEL\_TYPE

### A.27.2 Optional Keywords

Any

### A.27.3 Required Objects

None

### A.27.4 Optional Objects

None

### A.27.5 Example

Following is an example of a SPICE CK (pointing) kernel label. This label would be attached to the CK file, and thus would be immediately followed by the internal CK file header. (This example was fabricated for use here based on existing examples.)

```

PDS_VERSION_ID          = PDS3
RECORD_TYPE              = STREAM
MISSION_NAME             = MARS_OBSERVER
SPACECRAFT_NAME         = MARS_OBSERVER
DATA_SET_ID              = "MO-M-SPICE-6-CK-V1.0"
FILE_NAME                = "NAF0000D.TC"
PRODUCT_ID               = "NAF0000D-CK"
PRODUCT_CREATION_TIME    = 1992-04-14T12:00:00
PRODUCER_ID              = "NAIF"
MISSION_PHASE_TYPE       = "ORBIT"
PRODUCT_VERSION_TYPE     = "TEST"
START_TIME                = 1994-01-06T00:00:00
STOP_TIME                 = 1994-02-04T23:55:00
SPACECRAFT_CLOCK_START_COUNT = "3/76681108.213"
SPACECRAFT_CLOCK_STOP_COUNT = "4/79373491.118"
TARGET_NAME              = MARS
INSTRUMENT_NAME          = "MARS OBSERVER SPACECRAFT"
INSTRUMENT_ID            = MO
SOURCE_PRODUCT_ID        =
    {"NAF0000C.BSP", "NAF0000C.TLS", "NAF0000C.TSC"}
NOTE                      = "BASED ON EPHEMERIS IN NAF0000C.BSP. FOR
    SOFTWARE TESTING ONLY."
OBJECT                   = SPICE_KERNEL

```

```
INTERCHANGE_FORMAT      = ASCII
KERNEL_TYPE             = POINTING
DESCRIPTION              = "This is a SPICE kernel file, designed
  to be accessed using NAIF Toolkit software. Contact your flight
  project representative or the NAIF node of the Planetary Data System
  if you wish to obtain a copy of the NAIF Toolkit. The Toolkit
  consists of portable FORTRAN 77 code and extensive user
  documentation."
END_OBJECT              = SPICE_KERNEL
END
```

## A.28 SPREADSHEET

The SPREADSHEET is a natural storage format for data products in which the data rows are sparsely populated or field values have variable lengths.

A SPREADSHEET definition describes a collection of logically uniform rows containing ASCII values stored in variable-width fields separated by field delimiters. Each row within a SPREADSHEET has the same number of fields, in the same field order; and each field contains the same logical content. By definition, the SPREADSHEET object is used only to describe ASCII data objects. Therefore, it is not necessary to include the INTERCHANGE\_FORMAT keyword within the object keyword list. The rows and fields of the SPREADSHEET object provide a natural correspondence to the rows and columns of fixed-width tables. Each field is defined by a variable width FIELD object (see section A.14); the value of the FIELDS keyword is the total number of FIELD objects defined in the SPREADSHEET. All SPREADSHEET objects have variable-length records and have rows delimited by carriage-return line-feed (<CR><LF>) ASCII line termination characters.

### A.28.1 Required Keywords

4. ROWS
5. ROW\_BYTES
6. FIELDS
7. FIELD\_DELIMITER

### A.28.2 Optional Keywords

10. NAME
11. DESCRIPTION
12. PSDD

### A.28.3 Required Objects

1. FIELD

### A.28.4 Optional Objects

None

Notes:

1. The `RECORD_BYTES` keyword in the implied file object definition of the PDS label containing a `SPREADSHEET` object definition should specify the actual number of bytes in the longest record within the file being described. If the file contains several components, this longest record may not necessarily be in the `SPREADSHEET`.
2. The `ROW_BYTES` keyword within the `SPREADSHEET` object definition is used to specify the maximum number of bytes that could be contained in a row in the `SPREADSHEET` object (i.e. the sum of all the `FIELD` object `BYTES` values, plus the number of delimiters and quotation marks, plus the 2 bytes for the `<CR><LF>` line termination).

### **A.28.5 Required SPREADSHEET Formats**

The `SPREADSHEET` is an ASCII data object. Its records contain fixed numbers of variable-length fields and are delimited by carriage-return line-feed pairs. The `FIELD` delimiter can be `COMMA`, `SEMICOLON`, `TAB`, or `VERTICAL_BAR`; subfields (if any) are delimited by the same character.

The ASCII format makes the `SPREADSHEET` readable by both machines and humans. The relative loss in human readability (compared to the `TABLE` object) is mitigated by more efficient storage, especially for sparsely populated fields.

Several keywords take on special meanings in the `SPREADSHEET` context. `BYTES` (and `ITEM_BYTES`, if used) gives the maximum allowable number of bytes in the `FIELD` (`ITEM`). `ROW_BYTES` is the maximum allowable number of bytes in the row, including delimiters, quotation marks, and the carriage-return line-feed pair. `RECORD_TYPE` within the implied parent file object is always `STREAM`. `RECORD_BYTES` within the implied file is the actual number of bytes in the longest record, including the carriage-return line-feed pair. If the file contains more than the `SPREADSHEET`, however, the longest record may not be a `SPREADSHEET` record.

### **A.28.6 Recommended SPREADSHEET Formats**

The recommended format for `SPREADSHEET` objects is a comma-separated value format in which string fields are enclosed in double quotes. This format can be imported directly into many commercial data management systems and spreadsheet applications.

The recommended file name extension for files containing `SPREADSHEET` objects is `CSV` (e.g., `MYDATA.CSV`), but the `CSV` extension does not necessarily imply that the field delimiter is `COMMA`.

Example - Recommended `SPREADSHEET`

The following example shows a sparse matrix described as a SPREADSHEET object. The longest record is 85-bytes. Note that delimiters (double quotes and commas) and line terminators (<CR><LF>) are included in the byte count for each record (RECORD\_BYTES) and row (ROW\_BYTES).

Contents of file "MYDATA.CSV":

```
2004-03-04T00:00:00.012,0.45,"MODE 1",0,,,1,,, -1,12,5,1,2,1,1,0,1,3,1,0<CR><LF>
2004-03-04T00:00:01.012,0.45,"MODE 1",1,,,1,,,6,9,15,8,7,2,1,1,0,0,1,0<CR><LF>
2004-03-04T00:00:02.012,0.45,"MODE 1",2,,,5,,,25,15,10,4,2,1,1,1,1,0,1,1<CR><LF>
2004-03-04T00:00:03.012,0.45,"MODE 1",1,,,1,,,2,4,8,3,1,1,1,1,1,1,0,0<CR><LF>
2004-03-04T00:00:04.012,0.45,"MODE 5",1,1,3,1,1,2,3,1,1,2,2,1,4,3,1,1,4,1,1,0<CR><LF>
2004-03-04T00:00:05.012,0.45,"MODE 5",1,5,4,2,1,1,1,1,2,0,0,1,0,1,1,0,0,0,0,0<CR><LF>
2004-03-04T00:00:06.012,0.45,"MODE 5",1,6,3,5,4,3,1,,0,1,1,1,1,2,1,1,1,3,1,0<CR><LF>
2004-03-04T00:00:07.012,0.45,"MODE 6",,,,3,,,5,,1,,1,3,,2,3,,,,, <CR><LF>
2004-03-04T00:00:08.012,0.45,"MODE 6",,,,,,1,,,2,,1,,1,4,,1,2,,,,, <CR><LF>
2004-03-04T00:00:09.012,0.45,"MODE 6",,,,,,1,,,,,1,1,1,,,,,1,,,,, <CR><LF>
2004-03-04T00:00:10.017,4.00,"MODE 11",,,,,,8,15,14,21,24,18,15,10,8,9,11,6,-1,9,8,6<CR><LF>
2004-03-04T00:00:15.017,4.00,"MODE 11",,,,,,8,12,17,35,20,12,5,1,2,1,1,8,11,7,8,6<CR><LF>
2004-03-04T00:00:20.017,4.00,"MODE 11",,,,,,4,8,12,32,24,12,15,4,3,1,1,6,7,3,5,2<CR><LF>
2004-03-04T00:00:25.017,4.00,"MODE 13",,,,,,1,5,12,12,14,12,5,1,1,7,2,4,,,,, <CR><LF>
2004-03-04T00:00:30.017,4.00,"MODE 13",,,,,,1,5,5,14,16,10,8,3,1,5,3,2,,,,, <CR><LF>
2004-03-04T00:00:35.017,4.00,"MODE 13",,,,,,1,2,3,2,19,43,21,17,4,8,3,1,,,,, <CR><LF>
2004-03-04T00:00:40.017,4.00,"MODE 13",,,,,,1,2,1,2,4,12,9,3,1,1,1,1,,,,, <CR><LF>
2004-03-04T00:00:45.017,4.00,"MODE 13",,,,,,1,3,1,-1,9,16,7,1,1,1,1,2,,,,, <CR><LF>
2004-03-04T00:00:50.017,4.00,"MODE 13",,,,,,1,2,1,2,4,12,5,1,1,1,1,1,,,,, <CR><LF>
2004-03-04T00:00:55.017,4.00,"MODE 13",,,,,,1,2,1,2,4,10,5,1,1,1,1,1,,,,, <CR><LF>
```

MYDATA.CSV is an example data file described by a SPREADSHEET object definition within a PDS label. The longest record in this file is 85 bytes (record 11) and this value is assigned to the RECORD\_BYTES keyword. However, records described by this SPREADSHEET definition could be as long as 163 bytes (see example label below). The value assigned to the ROW\_BYTES keyword (163) is the maximum possible row size (bytes) described by the SPREADSHEET object definition.

Bytes	Field
23	- Time (23)
8	- delimiter + duration (7)
10	- delimiter + quotes(2) + mode string (7)
60	- delimiter + electrons (59)
60	- delimiter + ions (59)
+ 2	- CR + LF
-----	
= 163	= ROW_BYTES

Contents of file "MYDATA.LBL":

```
PDS_VERSION_ID          = PDS3
RECORD_TYPE              = STREAM
RECORD_BYTES             = 85      /* Largest actual record in the file */
FILE_RECORDS             = 20
^SPREADSHEET            = "MYDATA.CSV"
DATA_SET_ID              = "CO-S-INST-2-DUMMY-DATA-V1.0"
SPACECRAFT_NAME          = "CASSINI ORBITER"
INSTRUMENT_NAME          = "MY INSTRUMENT"
TARGET_NAME              = {"SATURN", "SOLAR_WIND"}
PRODUCT_ID               = "MYDATA.CSV"
```

```

PRODUCT_CREATION_TIME = 2004-08-04T11:15:00
START_TIME             = 2004-03-04T00:00:00.012
STOP_TIME              = 2004-03-04T00:00:55.017
DESCRIPTION             = "This file contains an example
                        sparse matrix data object (SPREADSHEET)."
```

```

OBJECT                 = SPREADSHEET
  ROWS                 = 20
  ROW_BYTES            = 163      /* Size of longest possible row*/
  FIELDS               = 5
  FIELD_DELIMITER     = "COMMA"
```

```

OBJECT                 = FIELD
  NAME                 = "TIME"
  DATA_TYPE           = TIME
  FIELD_NUMBER         = 1
  BYTES                = 23
  DESCRIPTION          = "Spacecraft event time (UT) for this data record."
END_OBJECT             = FIELD
```

```

OBJECT                 = FIELD
  NAME                 = "DURATION"
  FIELD_NUMBER         = 2
  BYTES                = 7
  FORMAT               = "F7.2"
  DATA_TYPE           = "ASCII_REAL"
  UNITS                = "SECOND"
  DESCRIPTION          = "Time interval over which counting was performed
                        (seconds)."
```

```

END_OBJECT             = FIELD
```

```

OBJECT                 = FIELD
  NAME                 = "MODE"
  FIELD_NUMBER         = 3
  BYTES                = 7 /* doesn't count bytes occupied by double
quotes*/
  FORMAT               = "A7"
  DATA_TYPE           = "CHARACTER"
  DESCRIPTION          = "Scan mode name. See the instrument description for
                        a complete list of scan mode names and
                        properties."
END_OBJECT             = FIELD
```

```

OBJECT                 = FIELD
  NAME                 = "ELECTRON COUNTS"
  FIELD_NUMBER         = 4
  BYTES                = 59      /* Maximum bytes including item delimiters */
  ITEMS                = 10
  ITEM_BYTES           = 5       /* Maximum item bytes */
  FORMAT               = "I5"
  DATA_TYPE           = "ASCII_INTEGER"
  UNITS                = "COUNTS"
  MISSING_CONSTANT     = -1
  DESCRIPTION          = "This field contains electron counts from channels
                        E1-E10. Items without values indicate channels not
                        counted during the interval. Values of zero denote
                        counted channels in which no electrons were
                        detected. Values of -1 denote corrupted data,"
```

```
                                excluded from the data file (counted, but value
                                undefined)."
```

END\_OBJECT = FIELD

OBJECT = FIELD

  NAME = "ION COUNTS"

  FIELD\_NUMBER = 5 /\* 5th FIELD object in label \*/

  BYTES = 59

  ITEMS = 10

  ITEM\_BYTES = 5

  FORMAT = "I5"

  DATA\_TYPE = "ASCII\_INTEGER"

  UNITS = "COUNTS"

  MISSING\_CONSTANT = -1

  DESCRIPTION = "This field contains ion counts from channels D1-  
D10. Items without values indicate channels not  
counted during the interval. Values of zero  
denote counted channels in which no ions were  
detected. Values of -1 denote corrupted data,  
excluded from the data file (counted, but value  
undefined)."

END\_OBJECT = FIELD

END\_OBJECT = SPREADSHEET

END

## **A.29 TABLE**

TABLEs are a natural storage format for collections of data from many instruments. They are often the most effective way of storing much of the meta-data used to identify and describe instrument observations.

The TABLE object is a uniform collection of rows containing ASCII or binary values stored in columns. The INTERCHANGE\_FORMAT keyword is used to distinguish between TABLEs containing only ASCII columns and those containing binary data. The rows and columns of the TABLE object provide a natural correspondence to the records and fields often defined in interface specifications for existing data products. Each field is defined as a fixed-width COLUMN object; the value of the COLUMNS keyword is the total number of COLUMN objects defined in the label. All TABLE objects must have fixed-width records.

Many variations on the basic TABLE object are possible with the addition of optional keywords and/or objects. While it is possible to create very complex row structures, these are often not the best choices for archival data products. Recommended ASCII and binary table formats are described and illustrated below.

### **A.29.1 Keywords**

#### **A.29.1.1 Required Keywords**

1. INTERCHANGE\_FORMAT
2. ROWS
3. COLUMNS
4. ROW\_BYTES

#### **A.29.1.2 Optional Keywords**

1. NAME
2. DESCRIPTION
3. ROW\_PREFIX\_BYTES
4. ROW\_SUFFIX\_BYTES
5. TABLE\_STORAGE\_TYPE

#### **A.29.1.3 Required Objects**

1. COLUMN

#### **A.29.1.4 Optional Objects**



## 1. CONTAINER

### A.29.2 ASCII vs. BINARY formats

ASCII tables provide the most portable format for access across a wide variety of computer platforms. They are also easily imported into a number of database management systems and spreadsheet applications. For these reasons, the PDS recommends the use of ASCII table formats whenever possible for archive products.

ASCII formats are generally less efficient for storing large quantities of numeric data. In addition, raw or minimally processed data products and many pre-existing data products undergoing restoration are only available in binary formats. Where conversion to an ASCII format is not cost effective or is otherwise undesirable, BINARY table formats may be used.

### A.29.3 Recommended ASCII TABLE Format

The recommended format for ASCII TABLE files is a comma-separated value format in which the string fields are enclosed in double quotes. ASCII tables must have fixed-length records and should use carriage-return/linefeed (<CR><LF>) delimiters. Numeric fields are right-justified in the allotted space and character fields are left-justified and blank padded on the right. This table format can be imported directly into many commercial data management systems.

The field delimiters and quotation marks must occur between the defined COLUMNS. That is, the START\_BYTE for a string column should not point to the opening quotation mark, but the first character in the field itself. Similarly, the BYTES values for the columns should not include the commas at the end of the values. For example, a twelve character COLUMN called SPACECRAFT\_NAME would be represented in the table as "VOYAGER 1" rather than "VOYAGER 1" or "VOYAGER 1".

The following label fragment illustrates the general characteristics of the recommended ASCII TABLE format for a table with 1000-byte records:

RECORD_TYPE	=	FIXED_LENGTH	← 1000 →	Record
RECORD_BYTES	=	1000		
...				
OBJECT	=	TABLE		
INTERCHANGE_FORMAT	=	ASCII		
ROW_BYTES	=	1000		
...				
END_OBJECT	=	TABLE		

Row 1	CR	LF	1
Row 2	CR	LF	2
.			.
.			.
.			.
Row n	CR	LF	n

### A.29.3.1 Example - Recommended ASCII TABLE

The following example is an ASCII index table with 71-byte records. Note that for ASCII tables, the delimiters (double quotes and commas) and line terminators (<CR><LF>) are included in the byte count for each record (RECORD\_BYTES). In this example, the delimiters are also included in the byte count for each row (ROW\_BYTES). The <CR><LF> characters have been placed in columns 70 and 71.

**Note:** The example following is an INDEX\_TABLE, a specific type of (ASCII) TABLE object. Two rows of numbers indicating the byte count (read vertically) have been added above the data file contents to facilitate comparison with the label. These rows would *not* appear in the actual data file.

Contents of file "INDEX.TAB":

```
0000000001111111111222222222233333333333444444444455555555556666666666 7 7
123456789012345678901234567890123456789012345678901234567890123456789 0 1
"F-MIDR ", "F-MIDR.40N286;1 ", "C", 42, 37,289,282, "F40N286/FRAME.LBL "<CR><LF>
"F-MIDR ", "F-MIDR.20N280;1 ", "C", 22, 17,283,277, "F20N280/FRAME.LBL "<CR><LF>
"F-MIDR ", "F-MIDR.20N286;1 ", "C", 22, 17,289,283, "F20N286/FRAME.LBL "<CR><LF>
"F-MIDR ", "F-MIDR.00N279;1 ", "R", 2, -2,281,275, "F00N279/FRAME.LBL "<CR><LF>
"F-MIDR ", "F-MIDR.05N290;1 ", "C", 7, 2,292,286, "F05N290/FRAME.LBL "<CR><LF>
"F-MIDR ", "F-MIDR.05S279;1 ", "R", -2, -7,281,275, "F05S279/FRAME.LBL "<CR><LF>
"F-MIDR ", "F-MIDR.10S284;1 ", "C", -7,-12,287,281, "F10S284/FRAME.LBL "<CR><LF>
"F-MIDR ", "F-MIDR.10S290;1 ", "R", -7,-12,292,286, "F10S290/FRAME.LBL "<CR><LF>
"F-MIDR ", "F-MIDR.15S283;1 ", "R", -12,-17,286,279, "F15S283/FRAME.LBL "<CR><LF>
"F-MIDR ", "F-MIDR.15S289;1 ", "R", -12,-17,291,285, "F15S289/FRAME.LBL "<CR><LF>
```

Contents of file "INDEX.LBL":

```
PDS_VERSION_ID          = PDS3
RECORD_TYPE             = FIXED_LENGTH
RECORD_BYTES           = 71
FILE_RECORDS           = 10
^INDEX_TABLE           = "INDEX.TAB"

DATA_SET_ID             = "MGN-V-RDRS-5-MIDR-FULL-RES-V1.0"
VOLUME_ID              = MG_7777
PRODUCT_ID             = "FMIDR.XYZ"
SPACECRAFT_NAME        = MAGELLAN
INSTRUMENT_NAME        = "RADAR SYSTEM"
TARGET_NAME            = VENUS
PRODUCT_CREATION_TIME  = 1999-02-23t11:15:07
MISSION_PHASE_NAME     = PRIMARY_MISSION
NOTE                   = "This table lists all MIDRs on this
                        volume. It also includes the latitude and longitude range for each
                        MIDR and the directory in which it is found."
```

OBJECT	= INDEX_TABLE
INTERCHANGE_FORMAT	= ASCII
ROWS	= 10
COLUMNS	= 8
ROW_BYTES	= 71
INDEX_TYPE	= SINGLE
OBJECT	= COLUMN
NAME	= PRODUCT_TYPE
DESCRIPTION	= "Magellan DMAT type code. Possible values are F-MIDR, C1-MIDR, C2-MIDR, C3-MIDR, and P-MIDR."
DATA_TYPE	= CHARACTER
START_BYTE	= 2
BYTES	= 7
END_OBJECT	= COLUMN
OBJECT	= COLUMN
NAME	= PRODUCT_ID
DESCRIPTION	= "Magellan DMAT name of product. Example: F-MIDR.20N334;1"
DATA_TYPE	= CHARACTER
START_BYTE	= 12
BYTES	= 16
END_OBJECT	= COLUMN
OBJECT	= COLUMN
NAME	= SEAM_CORRECTION_TYPE
DESCRIPTION	= "A value of C indicates that cross-track seam correction has been applied. A value of R indicates that the correction has not been applied."
DATA_TYPE	= CHARACTER
START_BYTE	= 31
BYTES	= 1
END_OBJECT	= COLUMN
OBJECT	= COLUMN
NAME	= MAXIMUM_LATITUDE
DESCRIPTION	= "Northernmost frame latitude rounded to the nearest degree."
DATA_TYPE	= INTEGER
UNIT	= DEGREE
START_BYTE	= 34
BYTES	= 3
END_OBJECT	= COLUMN
OBJECT	= COLUMN
NAME	= MINIMUM_LATITUDE
DESCRIPTION	= "Southernmost frame latitude rounded to the nearest degree."
DATA_TYPE	= INTEGER
UNIT	= DEGREE
START_BYTE	= 38

```

        BYTES = 3
    END_OBJECT = COLUMN

    OBJECT = COLUMN
        NAME = EASTERNMOST_LONGITUDE
        DESCRIPTION = "Easternmost frame longitude rounded to
            the nearest degree."
        DATA_TYPE = INTEGER
        UNIT = DEGREE
        START_BYTE = 42
        BYTES = 3
    END_OBJECT = COLUMN

    OBJECT = COLUMN
        NAME = WESTERNMOST_LONGITUDE
        DESCRIPTION = "Westernmost frame longitude rounded to
            the nearest degree."
        DATA_TYPE = INTEGER
        UNIT = DEGREE
        START_BYTE = 46
        BYTES = 3
    END_OBJECT = COLUMN

    OBJECT = COLUMN
        NAME = FILE_SPECIFICATION_NAME
        DESCRIPTION = "Path and file name of frame table
            relative to CD-ROM root directory."
        DATA_TYPE = CHARACTER
        START_BYTE = 51
        BYTES = 18
    END_OBJECT = COLUMN

    END_OBJECT = INDEX_TABLE
END

```

#### A.29.4 Recommended BINARY TABLE Format

In the case of binary data, PDS recommends a format in which one data record corresponds to one row in the TABLE. Unused or spare bytes embedded within the record should be defined as COLUMNS (one for each chunk of contiguous unused bytes) named "SPARE", both for completeness and to facilitate automated validation of the TABLE structure. For reasons of portability, BIT\_COLUMN objects within COLUMNS are discouraged. Whenever possible, bit fields should be unpacked into more portable, byte-oriented COLUMNS.

The following label fragment illustrates the general characteristics of the recommended binary TABLE format for a table with 1000-byte records:

RECORD_TYPE	=	FIXED_LENGTH	← 1000 →		Record
RECORD_BYTES	=	1000		Row 1	1
...				Row 2	2
OBJECT	=	TABLE		.	.
INTERCHANGE_FORMAT	=	BINARY		.	.
ROW_BYTES	=	1000		.	.
...					
END_OBJECT	=	TABLE		Row n	n

### A.29.4.1 Example - Recommended Binary TABLE

Following is an example of a binary table containing three columns of data. The first two columns provide TIME information in both the PDS standard UTC format and an alternate format. The third column provides uncalibrated instrument measurements for the given time. The binary data reside in the file "T890825.DAT". The detached label file, "T890825.LBL" providing the complete description, is presented below.

**Note:** The label makes use of a format file, pointed to by the ^STRUCTURE keyword in the TABLE definition, to include a set of column definitions held in an external file ("CRSDATA.FMT"). The contents of this structure file are also provided below.

This table could also be represented as a TIME\_SERIES by the addition of sampling parameter keywords to describe the row-to-row variation in the table.

Contents of label file "T890825.DAT":

byte	1	8 9	32 33	36		<u>Record</u>
		Row 1				1
	C TIME	PDS TIME	D1	RATE		.
	.	.				.
	.	.				.
	.	.				.
		Row 350				350

Contents of label file "T890825.LBL":

```

PDS_VERSION_ID          = PDS3

/* File Characteristic Keywords */
RECORD_TYPE             = FIXED_LENGTH
RECORD_BYTES           = 36
FILE_RECORDS           = 350
HARDWARE_MODEL_ID      = "SUN SPARC STATION"
OPERATING_SYSTEM_ID    = "SUN OS 4.1.1"

/* Data Object Pointers */
^TABLE                  = "T890825.DAT"

/* Identification Keywords */
DATA_SET_ID             = "VG2-N-CRS-4-SUMM-D1-96SEC-V1.0"
SPACECRAFT_NAME        = "VOYAGER 2"
INSTRUMENT_NAME        = "COSMIC RAY SYSTEM"
TARGET_NAME            = "NEPTUNE"
START_TIME              = 1989-08-25T00:00:00.000
STOP_TIME               = 1989-08-25T09:58:02.000
MISSION_PHASE_NAME     = "NEPTUNE ENCOUNTER"
PRODUCT_ID              = "T890825.DAT"
PRODUCT_CREATION_TIME  = "UNK"
SPACECRAFT_CLOCK_START_COUNT = "UNK"
SPACECRAFT_CLOCK_STOP_COUNT = "UNK"

/* Data Object Descriptions */
OBJECT                  = TABLE
  INTERCHANGE_FORMAT    = BINARY
  ROWS                  = 350
  COLUMNS              = 3
  ROW_BYTES             = 36
  ^STRUCTURE            = "CRSDATA.FMT"
END_OBJECT              = TABLE
END

```

#### Contents of file "CRSDATA.FMT":

```

OBJECT                  = COLUMN
  NAME                  = "C TIME"
  UNIT                  = "SECOND"
  DATA_TYPE            = REAL
  START_BYTE           = 1
  BYTES                 = 8
  MISSING               = 1.0E+32
  DESCRIPTION           = "Time column. This field contains time
                          in seconds after Jan 01, 1966 but is
                          displayed in the default time format
                          selected by the user."
END_OBJECT              = COLUMN

OBJECT                  = COLUMN

```

```

NAME                = "PDS TIME"
UNIT                = "TIME"
DATA_TYPE           = TIME
START_BYTE          = 9
BYTES               = 24
DESCRIPTION         = "Date/Time string of the form yyyy-mm-
                        ddThh:mm:ss.sss such that the representation of the date Jan 01,
                        2000 00:00:00.000 would be 2000-01-01T00:00:00.000."
END_OBJECT          = COLUMN

OBJECT              = COLUMN
NAME                = "D1 RATE"
UNIT                = "COUNT"
DATA_TYPE           = "REAL"
START_BYTE          = 33
BYTES               = 4
MISSING             = 1.0E+32
DESCRIPTION         = "The D1 rate is approximately
                        porportional to the omnidirectional flux of electrons with kinetic
                        energy > ~1MeV. To obtain greater accuracy, the D1 calibration
                        tables (see catalog) should be applied."
END_OBJECT          = COLUMN

```

### A.29.5 TABLE Variations

This section addresses a number of variations on the basic TABLE object that arise when TABLEs appear in data files with other objects, or where file attributes may differ from the one row-one record approach recommended above. The variations discussed below are equally applicable to the other TABLE-type objects, SERIES and SPECTRUM.

This section is not intended to be a complete reference for TABLE variations. Within the following examples, some illustrate a recommended data modelling approach, some illustrate alternate approaches, and other examples are included solely to document their existence.

#### A.29.5.1 Record blocking in Fixed Length TABLES

In the PDS recommended TABLE format, ROW\_BYTES = RECORD\_BYTES, but this is not always achievable. TABLEs are sometimes packaged with other objects in the same file, or binary data may be blocked into larger records, both resulting in cases where the TABLE row size will not match the file record width.

Rows in either ASCII or binary tables may be either larger or smaller than the physical record size specified by the RECORD\_BYTES keyword. Regardless of the relationship between row size and record size, the RECORD\_BYTES keyword must *always* reflect the actual physical record size, while ROW\_BYTES must *always* be the logical size of one row of the TABLE object.

### A.29.5.1.1 Example: Binary Table with *ROW\_BYTES* > *RECORD\_BYTES*

The following label fragment illustrates a case in which the record size of the file is smaller than the row size of the TABLE. Note that the table rows may straddle record boundaries. Each object, however, must begin on a record boundary, so it is possible that some padding may be required between the end of the TABLE object and the beginning of the IMAGE object, depending on the number of rows in the TABLE:

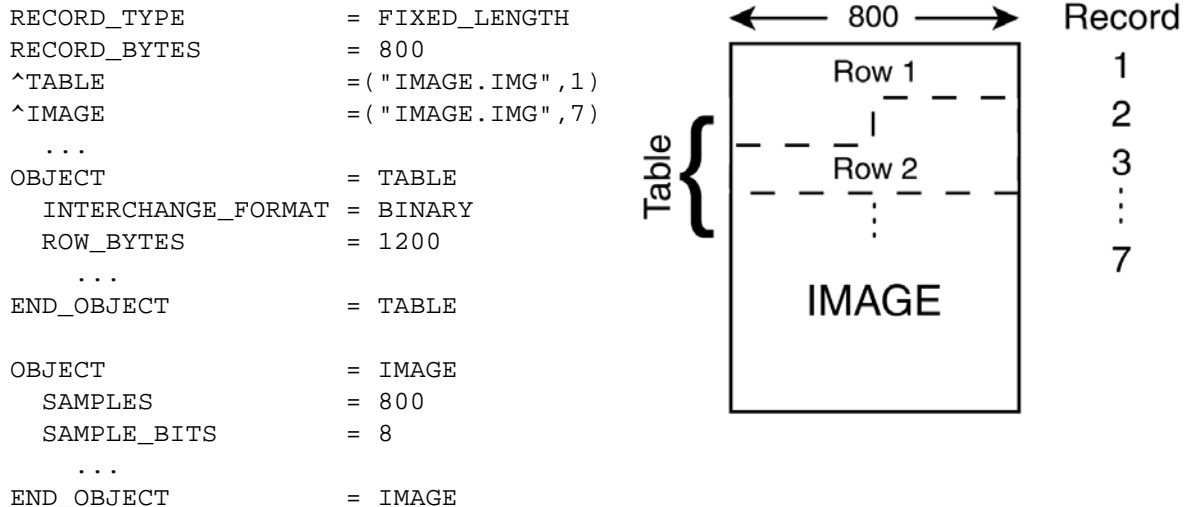

### A.29.5.1.2 Example: ASCII Table with *ROW\_BYTES* < *RECORD\_BYTES*

The label fragment below illustrates a case in which the row size of the TABLE is smaller than the record size of the file. It is not required that the file record size be an integral multiple of the table row size; as illustrated above, table rows may straddle record boundaries. Also as above, it is possible that some padding will be required to ensure that the subsequent SERIES object begins on a record boundary.

RECORD_TYPE	=	FIXED_LENGTH
RECORD_BYTES	=	800
^TABLE	=	("EXAMPLE.TAB", 1)
^SERIES	=	("EXAMPLE.TAB", 1214)
...		
OBJECT	=	TABLE
INTERCHANGE_FORMAT	=	ASCII
ROW_BYTES	=	400
...		
END_OBJECT	=	TABLE
OBJECT	=	SERIES
INTERCHANGE_FORMAT	=	ASCII
ROW_BYTES	=	800
...		

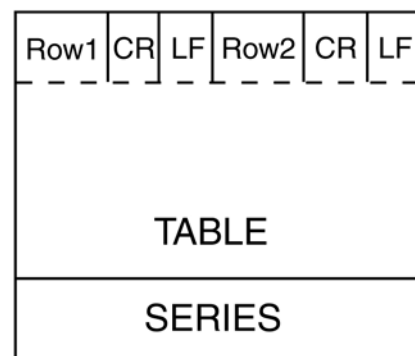



END\_OBJECT = SERIES

### A.29.5.1.3 Example: Binary Table with ROW\_BYTES < RECORD\_BYTES

It is often the case that a data object such as a TABLE is preceded by a header containing observational parameters or, as frequently happens with TABLES, a set of column headings. The label below illustrates a case in which a HEADER object containing a single 500-byte row precedes a TABLE having 1032-byte records. The file is physically blocked into records of 32,500 bytes. Note that in this case the HEADER record is *not* padded out to the full block size. Instead, a byte offset (rather than a record offset) is used to indicate the start of the TABLE object. (This example also includes COLUMN definitions contained in an external format file, a fragment of the contents of which is also shown below, following the label.)

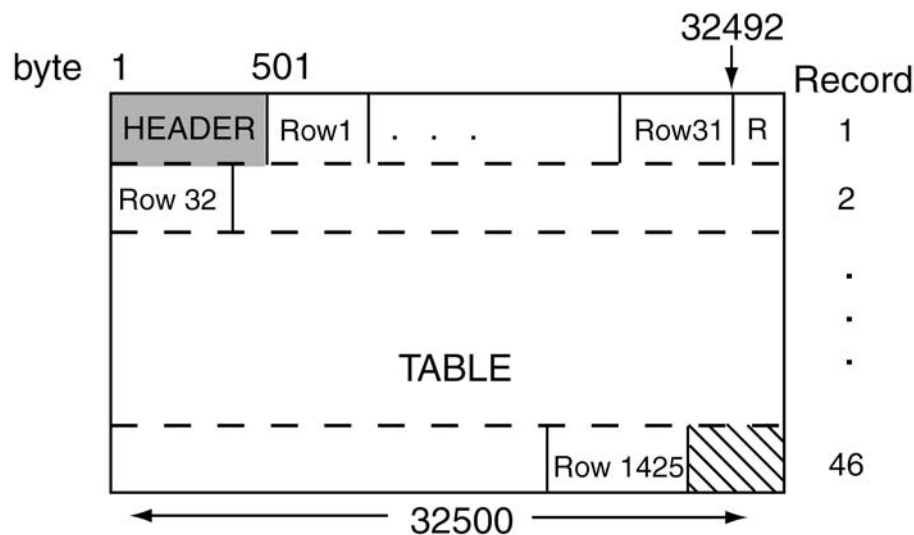

```

PDS_VERSION_ID          = PDS3

/* FILE CHARACTERISTICS */
RECORD_TYPE              = FIXED_LENGTH
RECORD_BYTES             = 32500
FILE_RECORDS             = 46
^HEADER                  = ("ADF01141.3", 1)
^TABLE                   = ("ADF01141.3", 501<BYTES>)

/* IDENTIFICATION KEYWORDS */
DATA_SET_ID              = "MGN-V-RDRS-5-CDR-ALT/RAD-V1.0"
PRODUCT_ID               = "ADF01141.3"
TARGET_NAME              = VENUS
SPACECRAFT_NAME          = MAGELLAN
INSTRUMENT_NAME          = "RADAR SYSTEM"
MISSION_PHASE_NAME       = PRIMARY_MISSION
PRODUCT_CREATION_TIME    = 1991-07-23T06:16:02.000
ORBIT_NUMBER             = 1141
START_TIME               = UNK

```

```

STOP_TIME = UNK
SPACECRAFT_CLOCK_START_COUNT = UNK
SPACECRAFT_CLOCK_STOP_COUNT = UNK
HARDWARE_VERSION_ID = 01
SOFTWARE_VERSION_ID = 02
UPLOAD_ID = M0356N
NAVIGATION_SOLUTION_ID = "ID = M0361-12 "
DESCRIPTION = "This file contains binary records
              describing, in time order, each altimeter footprint measured
              during an orbit of the Magellan radar mapper."

/* DATA OBJECT DEFINITION DESCRIPTIONS */
OBJECT = HEADER
  HEADER_TYPE = SFDU
  BYTES = 500
END_OBJECT = HEADER

OBJECT = TABLE
  INTERCHANGE_FORMAT = BINARY
  ROWS = 1425
  COLUMNS = 40
  ROW_BYTES = 1032
  ^STRUCTURE = "ADFTBL.FMT"
END_OBJECT = TABLE
END

```

#### Contents of format file "ADFTBL.FMT":

```

OBJECT = COLUMN
  NAME = SFDU_LABEL_AND_LENGTH
  START_BYTE = 1
  DATA_TYPE = CHARACTER
  BYTES = 20
  UNIT = "N/A"
  DESCRIPTION = "The SFDU_label_and_length element
                identifies the label and length of the Standard Format Data Unit
                (SFDU). "
END_OBJECT = COLUMN

OBJECT = COLUMN
  NAME = FOOTPRINT_NUMBER
  START_BYTE = 21
  DATA_TYPE = LSB_INTEGER
  BYTES = 4
  UNIT = "N/A"
  DESCRIPTION = "The footprint_number element provides a
                signed integer value. The altimetry and radiometry processing
                program assigns footprint 0 to that observed at nadir at periapsis.
                The remaining footprints are located along the spacecraft nadir
                track, with a separation that depends on the Doppler resolution of
                the altimeter at the epoch at which that footprint is observed. Pre-
                periapsis footprints will be assigned negative numbers, post-
                periapsis footprints will be assigned positive ones. A loss of

```

```

      several consecutive burst records from the ALT-EDR will result in
      missing footprint numbers."
END_OBJECT                = COLUMN
...

OBJECT                    = COLUMN
  NAME                    = DERIVED_THRESH_DETECTOR_INDEX
  START_BYTE              = 1001
  DATA_TYPE              = LSB_UNSIGNED_INTEGER
  BYTES                   = 4
  UNIT                    = "N/A"
  DESCRIPTION             = "The derived_thresh_detector_index
      element provides the value of the element in
      range_sharp_echo_profile that satisfies the altimeter threshold
      detection algorithm, representing the distance to the nearest object
      in this radar footprint in units of 33.2 meters, modulus a 10.02
      kilometer altimeter range ambiguity."
END_OBJECT                = COLUMN

```

#### A.29.5.1.4 Example: PDS Recommended Method for Dealing with Odd-Sized Headers

The preceding format may be difficult to deal with in some cases because of the odd-sized header preceding the TABLE object. The recommended approach to this situation is pad the HEADER object out to an integral multiple of the TABLE row size, and then let RECORD\_BYTES = ROW\_BYTES. Modifying the above case accordingly would yield the following:

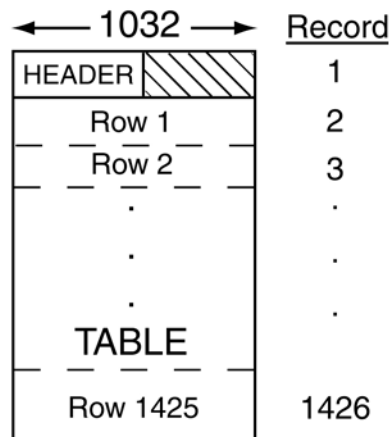

```

RECORD_TYPE              = FIXED_LENGTH
RECORD_BYTES             = 1032
FILE_RECORDS             = 1426
^HEADER                  = ("ADF01141.3",1)
^TABLE                   = ("ADF01141.3",2)
...

```

```
/* DATA OBJECT DEFINITIONS */
```

```

OBJECT          = HEADER
  HEADER_TYPE   = SFDU
  BYTES         = 500
END_OBJECT

OBJECT          = TABLE
  INTERCHANGE_FORMAT = BINARY
  ROWS          = 1425
  COLUMNS     = 40
  ROW_BYTES    = 1032
  ^STRUCTURE   = "ADFTBL.FMT"
END_OBJECT
END

```

### A.29.5.1.5 *Alternate Format – Rows on Record Boundaries*

The following label fragment and illustration provide a second alternate data organization for the preceding example. In this example, a record size of 30,960 is used to hold 30 rows of the TABLE. Again the 500-byte HEADER uses only a portion of the first record.

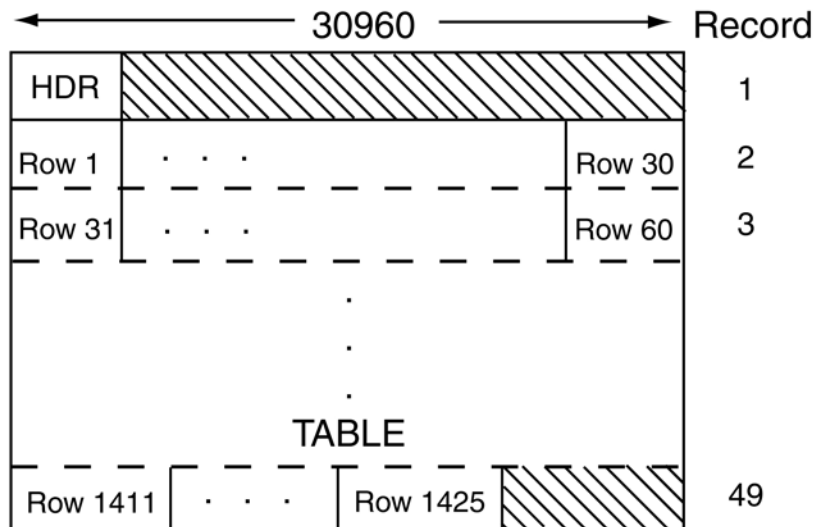

```

...
RECORD_TYPE      = FIXED_LENGTH
RECORD_BYTES    = 30960
FILE_RECORDS    = 49
^HEADER         = ("ADF01141.3",1)
^TABLE         = ("ADF01141.3")
...

```

```
/* DATA OBJECT DEFINITIONS */
```

```

OBJECT          = HEADER
  HEADER_TYPE   = SFDU

```

```

      BYTES                = 500
      END_OBJECT           = HEADER

      OBJECT               = TABLE
      INTERCHANGE_FORMAT   = BINARY
      ROWS                 = 1425
      COLUMNS             = 40
      ROW_BYTES            = 1032
      ^STRUCTURE           = "ADFTBL.FMT"
      END_OBJECT           = TABLE

```

### A.29.5.2 Multiple TABLES in a Single Data File

A single data product file may contain several ASCII or binary TABLES, each with a different logical row size. There are several possible approaches to formatting such a product file, depending on whether the product contains binary or ASCII data. When all the TABLES in the data file are ASCII tables there are two formatting options: fixed-length file records or stream records. When binary data are involved, even if only in a single TABLE, fixed-length file records are mandatory.

#### A.29.5.2.1 Example: Multiple ASCII tables – Fixed-Length Records

In the case of a series of ASCII TABLE objects with varying ROW\_BYTES values, a fixed-length record file may be generated by padding all rows of all TABLES out to the length of the longest rows by adding blank characters between the end of the last COLUMN and the <CR><LF> record delimiters.

When this approach is used, RECORD\_TYPE is FIXED\_LENGTH and RECORD\_BYTES = ROW\_BYTES.

```

      RECORD_TYPE          = FIXED_LENGTH
      RECORD_BYTES        = 1000
      ...
      OBJECT               = A_TABLE
      INTERCHANGE_FORMAT   = ASCII
      ROW_BYTES            = 1000
      ...
      END_OBJECT           = A_TABLE

      OBJECT               = B_TABLE
      INTERCHANGE_FORMAT   = ASCII
      ROW_BYTES            = 1000
      ...
      END_OBJECT           = B_TABLE

```

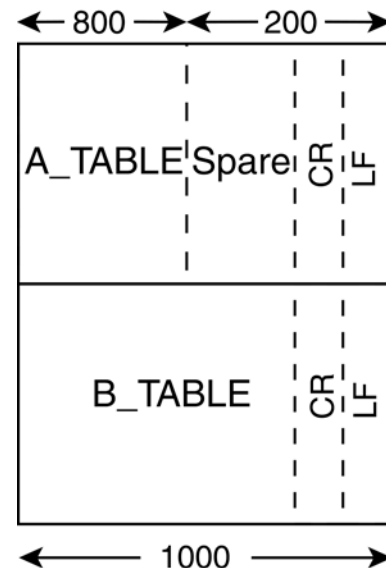

Note that each TABLE object has the same value of ROW\_BYTES, even though in the smaller table the rightmost bytes will be ignored. Alternately, the filler bytes may be documented as ROW\_SUFFIX\_BYTES. Say, for example, that in the above case B\_TABLE only required 780 bytes for its rows. The following definition for B\_TABLE marks the last 220 bytes of each row as suffix bytes:

```

OBJECT                = B_TABLE
  INTERCHANGE_FORMAT  = ASCII
  ROW_BYTES           = 780
  ROW_SUFFIX_BYTES    = 220
  ...

```

### A.29.5.2.2 *END\_OBJECT = B\_TABLE*

### A.29.5.2.3 *Example: Multiple ASCII tables – Stream Records*

Sometimes padding TABLE records out to a common fixed length creates more problems than it solves. When this is true each TABLE should retain its own ROW\_BYTES value, without padding, and the file RECORD\_TYPE is set to STREAM. RECORD\_BYTES should be omitted. The following label fragment illustrates this situation.

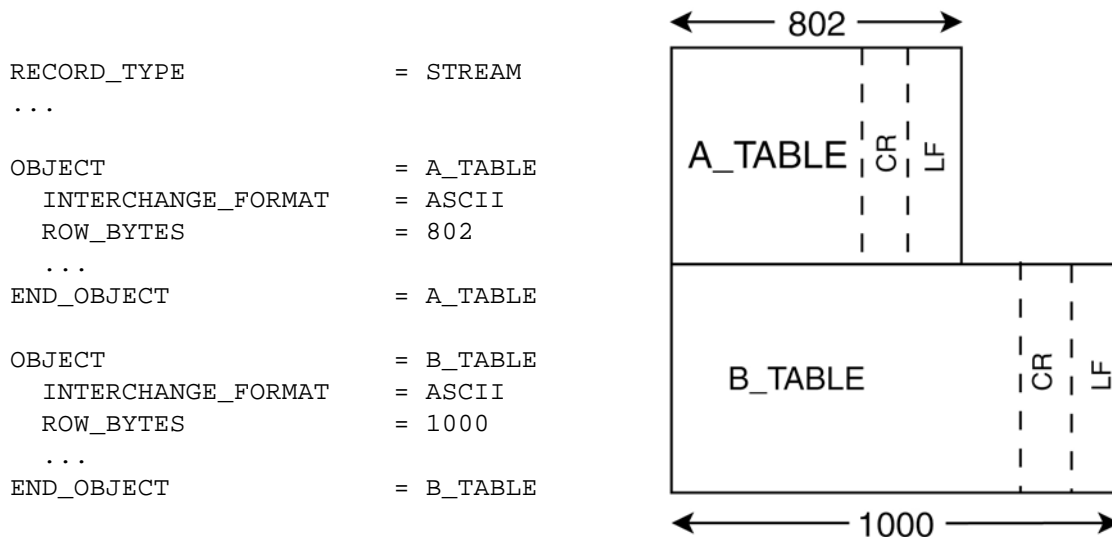

### A.29.5.2.3 *Example: Multiple Binary Tables – Fixed-Length Records*

When binary data are involved the file records *must* be fixed-length. The records of the smaller TABLE(s) are padded, usually with null characters, out to the maximum ROW\_BYTES value in the file. The padding bytes are accounted for in the TABLE definition using one of two methods: either by defining a COLUMN called “SPARE” to define the number and location of these spare bytes, or by using the ROW\_SUFFIX\_BYTES keyword, as in the case of multiple ASCII tables. In the following example, the first table, A\_TABLE, has a logical row length of 800 bytes. Each row has been padded out to 1000 bytes, the length of the B\_TABLE rows, with a 200-byte SPARE column:

```

RECORD_TYPE          = FIXED_LENGTH
RECORD_BYTES         = 1000

```

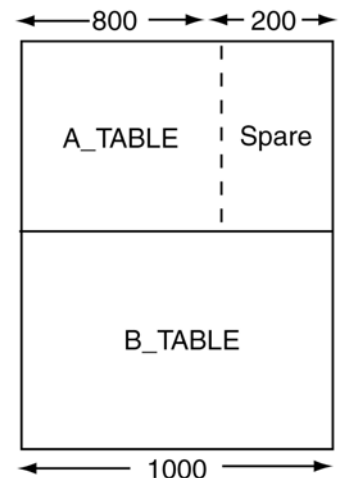

```

...
OBJECT                = A_TABLE
  INTERCHANGE_FORMAT  = BINARY
  ROW_BYTES           = 1000
...

OBJECT                = COLUMN
  NAME                 = "TIME TAG"
  DATA_TYPE           = TIME
  START_BYTE           = 1
  BYTES                = 23
  END_OBJECT           = COLUMN
...

OBJECT                = COLUMN
  NAME                 = "SPARE"
  DATA_TYPE           = "N/A"
  START_BYTE           = 801
  BYTES                = 200
  END_OBJECT           = COLUMN
END_OBJECT             = A_TABLE

OBJECT                = B_TABLE
  INTERCHANGE_FORMAT  = BINARY
  ROW_BYTES           = 1000
...
END_OBJECT             = B_TABLE

```

### A.29.5.3 ROW\_PREFIX or ROW\_SUFFIX Use

ROW\_PREFIX\_BYTES and ROW\_SUFFIX\_BYTES are provided for dealing with two situations:

1. When a TABLE object is stored in parallel with another data object, frequently an IMAGE. In this case, each physical record of the file contains a TABLE row as one part of the record and an IMAGE line as the other part.
2. When a TABLE has had each of its rows padded out to a fixed length larger than the logical row size of the table.

Each method is illustrated below.

#### A.29.5.3.1 *Example: Parallel TABLE and IMAGE objects*

The following label fragment illustrates a file with fixed-length records, each of which contains one row of a TABLE data object and one line of an IMAGE object. This is a common format for providing ancillary information applicable to each IMAGE line. In the TABLE object the bytes belonging to the IMAGE are accounted for as ROW\_SUFFIX\_BYTES. In the IMAGE object the bytes belonging to the TABLE row are accounted for as LINE\_PREFIX\_BYTES.

```

RECORD_TYPE      = FIXED_LENGTH
RECORD_BYTES     = 1000
...

OBJECT           = TABLE
  INTERCHANGE_FORMAT = BINARY
  ROW_BYTES       = 200
  ROW_SUFFIX_BYTES = 800
  ...
END_OBJECT

OBJECT           = IMAGE
  LINE_SAMPLES    = 800
  SAMPLE_BITS     = 8
  LINE_PREFIX_BYTES = 200
  ...
END_OBJECT

```

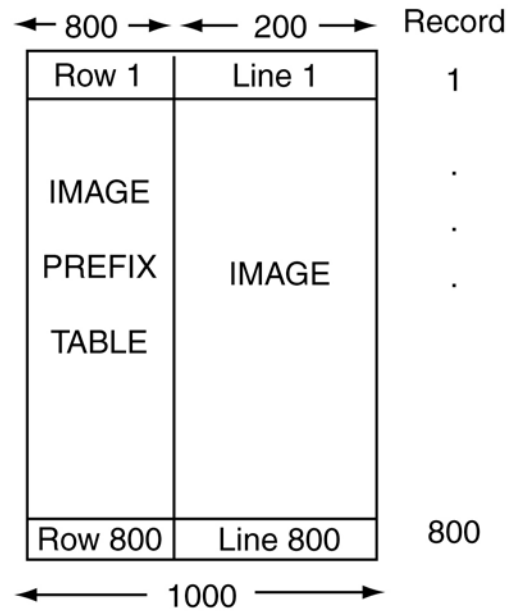

Note that in each object the total size of the logical record plus all prefix and suffix bytes is equal to the file record size. That is:

$$\text{RECORD\_BYTES} = \text{ROW\_BYTES} + \text{ROW\_PREFIX\_BYTES} + \text{ROW\_SUFFIX\_BYTES}$$

and

$$\text{RECORD\_BYTES} = (\text{LINE\_SAMPLES} * \text{SAMPLE\_BITS} / 8) + \text{ROW\_PREFIX\_BYTES} + \text{ROW\_SUFFIX\_BYTES}$$

#### A.29.5.4 CONTAINER Object use

Complex TABLEs may contain a set of columns of different data types which repeat a number of times in the row. In this case a CONTAINER object, which groups a set of inhomogeneous COLUMN objects, may be used to provide a single definition for the repeating group. Section A.8 contains an example of a TABLE object which makes use of a CONTAINER object.

#### A.29.5.5 Guidelines for SPARE fields

Some TABLE objects contain spare bytes embedded in the record but not included in any COLUMN object definition. They may be there for spacing or alignment purposes, or they may have been reserved in the original data record for future use. Regardless of their origin, PDS recommends that all such spare bytes be documented as COLUMNS in the TABLE definition in the interests of documentation and validation. Spare bytes may be included in both binary and ASCII table objects. Guidelines for dealing with spare bytes in both cases follow.

#### A.29.5.6 SPARE fields - Binary Tables



The following guidelines apply to spare byte fields in binary table objects:

- Embedded spare fields must be explicitly defined in COLUMN objects, except when the spare field appears at the beginning or end of a row where ROW\_PREFIX\_BYTES or ROW\_SUFFIX\_BYTES is used.
- Spare COLUMNs must have DATA\_TYPE = "N/A".
- Multiple spare COLUMNs may all specify NAME = "SPARE".
- Spare bytes may occur as prefix or suffix bytes in the rows.
- Prefix or suffix spares may be identified either with a spare COLUMN object or by use of ROW\_PREFIX\_BYTES or ROW\_SUFFIX\_BYTES

The following examples illustrate the various situations.

#### A.29.5.6.1 *Example: SPARE field embedded in a Binary TABLE*

In the following label fragment, a spare column defines a series of bytes reserved for future use in the middle of the data record:

```

RECORD_TYPE          = FIXED_LENGTH
RECORD_BYTES         = 1000
...
OBJECT               = TABLE
  INTERCHANGE_FORMAT = BINARY
  ROW_BYTES          = 1000
  COLUMNS           = 99
  ...
OBJECT               = COLUMN
  NAME                = SPARE
  COLUMN_NUMBER       = 87
  START_BYTE          = 793
  BYTES               = 21
  DATA_TYPE          = "N/A"
  DESCRIPTION         = "Reserved for future user by Mission Ops."
  END_OBJECT          = COLUMN
  ...
OBJECT               = COLUMN
  ...
END_OBJECT            = TABLE

```

Column 1 . . .

99

TABLE

Spare

E

← 800 →
← 20 →

← 1000 →

#### A.29.5.6.2 *Example: Spares at end of a Binary TABLE – Explicit 'SPARE' Column*

In this label fragment, spare bytes have been included on the end of each record of the table. These bytes are described as an additional COLUMN at the end of the record.

```

RECORD_TYPE          = FIXED_LENGTH
RECORD_BYTES        = 1000
...

OBJECT              = TABLE
  INTERCHANGE_FORMAT = BINARY
  ROW_BYTES         = 1000
  COLUMNS         = 99
  ...

OBJECT              = COLUMN
  COLUMN_NUMBER     = 1
  NAME              = "TIME TAG"
  ...
END_OBJECT

...

OBJECT              = COLUMN
  COLUMN_NUMBER     = 99
  NAME              = SPARE
  BYTES             = 20
  DATA_TYPE        = "N/A"
  START_BYTE        = 981
  ...
END_OBJECT
END_OBJECT          = TABLE

```

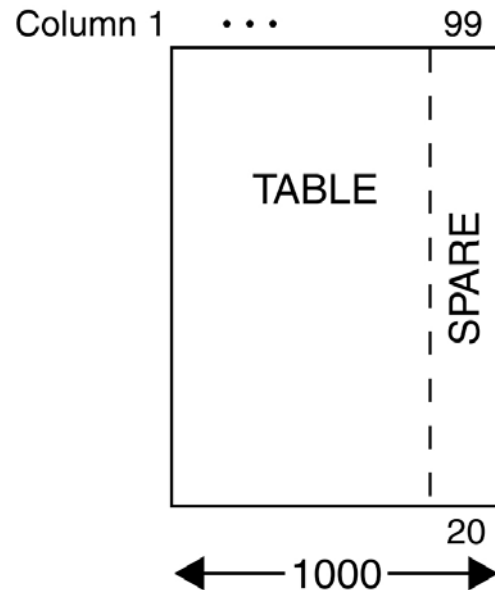

#### A.29.5.6.3 *Example: Spares at end of a Binary TABLE - ROW\_SUFFIX\_BYTES use*

This fragment illustrates the same physical file layout as the previous example, but in this case the spare bytes are defined using the ROW\_SUFFIX\_BYTES keyword, rather than defining an additional spare COLUMN.

```

RECORD_TYPE          = FIXED_LENGTH
RECORD_BYTES        = 1000
...

OBJECT              = TABLE
  INTERCHANGE_FORMAT = BINARY
  ROW_BYTES         = 980
  ROW_SUFFIX_BYTES  = 20
  COLUMNS         = 98
  ...
END_OBJECT          = TABLE

```

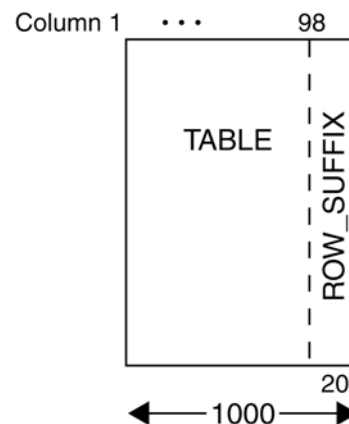

### A.29.5.7 SPARE fields - ASCII Tables with Fixed Length Records

In ASCII tables, field delimiters (") and (,) and the <CR><LF> pair are considered part of the data, even though the COLUMN objects attributes do not include them. Spare bytes in ASCII tables may contain only the blank character (ASCII decimal code 32). The following guidelines apply to spare byte fields in ASCII table objects:

- Embedded spares are not allowed.
- Spares are allowed at the end of each row of data.
- The <CR><LF> follows the spare data.
- There are no delimiters (commas or quotes) surrounding the spares.
- Spares at the end of the data can be ignored (like field delimiters and <CR><LF>) or they can be identified
  - (1) in the Table DESCRIPTION; or
  - (2) by using ROW\_SUFFIX\_BYTES (note that these bytes should not be included in the value of ROW\_BYTES)

#### A.29.5.7.1 Example - SPARE field at end of ASCII TABLE - Table description note

```

RECORD_TYPE          = FIXED_LENGTH
RECORD_BYTES        = 1000
...

OBJECT               = TABLE
  INTERCHANGE_FORMAT = ASCII
  ROW_BYTES          = 1000
...

DESCRIPTION          ="This table contains 980
  bytes of table data followed by 18 bytes of
  blank spares. Bytes 999 and 1000 contain the
  <CR><LF> pair."

```

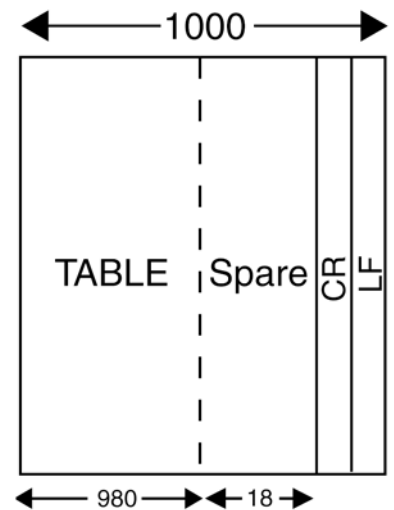

### A.29.5.7.2 *Example - Spares at end of a ASCII TABLE - ROW\_SUFFIX use*

```

RECORD_TYPE           = FIXED_LENGTH
RECORD_BYTES          = 1000
...
OBJECT                = TABLE
  INTERCHANGE_FORMAT  = ASCII
  ROW_BYTES           = 980
  ROW_SUFFIX_BYTES    = 20
  ...
DESCRIPTION           ="This table contains
  980 bytes of table data followed by 20
  bytes of spare data of which the last
  two bytes, bytes 999 and 1000, contain
  the <CR><LF> pair."
END_OBJECT            = TABLE

```

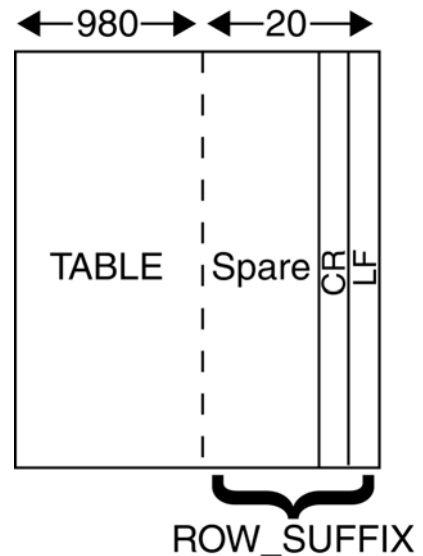

### A.29.5.8 SPARE fields - ASCII Tables with STREAM Records

Spare fields are not used with ASCII Tables in STREAM record formats. In STREAM files, the last data field explicitly defined with a COLUMN object is followed immediately by the <CR><LF> pair. Since there is no use for spares at the end of the data, and embedded spares are not allowed in ASCII tables, spares are not applicable here.

## A.30 TEXT

The TEXT object describes a file which contains plain text. It is most often used in an attached label, so that the text begins immediately after the END statement of the label. PDS recommends that TEXT objects contain no special formatting characters, with the exception of the carriage return/line feed sequence and the page break. Tab characters are discouraged, since they are interpreted differently by different programs.

Use of the carriage-return/line-feed sequence (<CR><LF>) is required for cross-platform support. PDS further recommends that text lines be limited to 80 characters, with delimiters, to facilitate visual inspection and printing of text files.

NOTE: The TEXT object is most often used for files describing the contents of an archive volume or the contents of a directory, such as AAREADME.TXT, DOCINFO.TXT, VOLINFO.TXT, SOFTINFO.TXT, etc. These files must be in plain, unmarked ASCII text and always have a file extension of “.TXT”. Documentation files that are in plain ASCII text, on the other hand, must be described using the DOCUMENT object. (See the definition of the DOCUMENT Object in Section A.12.)

The required NOTE field should provide a brief introduction to the TEXT.

### A.30.1 Required Keywords

1. NOTE
2. PUBLICATION\_DATE

### A.30.2 Optional Keywords

1. INTERCHANGE\_FORMAT

### A.30.3 Required Objects

None

### A.30.4 Optional Objects

None

### A.30.5 Example

The example below is a portion of an AAREADME.TXT file.

```

PDS_VERSION_ID          = PDS3
RECORD_TYPE             = STREAM

OBJECT                  = TEXT
  PUBLICATION_DATE      = 1991-05-28
  NOTE                   = "Introduction to this CD-ROM volume."
END_OBJECT              = TEXT
END

```

#### GEOLOGIC REMOTE SENSING FIELD EXPERIMENT

This set of compact read-only optical disks (CD-ROMs) contains a data collection acquired by ground-based and airborne instruments during the Geologic Remote Sensing Field Experiment (GRSFE). Extensive documentation is also included. GRSFE took place in July, September, and October, 1989, in the southern Mojave Desert, Death Valley, and the Lunar Crater Volcanic Field, Nevada. The purpose of these CD-ROMs is to make available in a compact form through the Planetary Data System (PDS) a collection of relevant data to conduct analyses in preparation for the Earth Observing System (EOS), Mars Observer (MO), and other missions. The generation of this set of CD-ROMs was sponsored by the NASA Planetary Geology and Geophysics Program, the Planetary Data System (PDS) and the Pilot Land Data System (PLDS).

This AAREADME.TXT file is one of the two nondirectory files located in the top level directory of each CD-ROM volume in this collection. The other file, VOLDESC.CAT, contains an overview of the data sets on these CD-ROMs and is written in a format that is designed for access by computers. These two files appear on every volume in the collection. All other files on the CD-ROMs are located in directories below the top level directory ....

## A.31 VOLUME

The VOLUME object describes a physical or logical unit used to store or distribute data products (e.g., a magnetic tape, CD-ROM disk, or floppy disk) that contain directories and files. The directories and files may include documentation, software, calibration and geometry information as well as the actual science data.

### A.31.1 Required Keywords

8. DATA\_SET\_ID
9. DESCRIPTION
10. MEDIUM\_TYPE
11. PUBLICATION\_DATE
12. VOLUME\_FORMAT
13. VOLUME\_ID
14. VOLUME\_NAME
15. VOLUME\_SERIES\_NAME
16. VOLUME\_SET\_NAME
17. VOLUME\_SET\_ID
18. VOLUME\_VERSION\_ID
19. VOLUMES

### A.31.2 Optional Keywords

13. BLOCK\_BYTES
14. DATA\_SET\_COLLECTION\_ID
15. FILES
16. HARDWARE\_MODEL\_ID
17. LOGICAL\_VOLUMES
18. LOGICAL\_VOLUME\_PATH\_NAME
19. MEDIUM\_FORMAT
20. NOTE
21. OPERATING\_SYSTEM\_ID
22. PRODUCT\_TYPE
23. TRANSFER\_COMMAND\_TEXT
24. VOLUME\_INSERT\_TEXT

### A.31.3 Required Objects

2. CATALOG
3. DATA\_PRODUCER

### A.31.4 Optional Objects

2. DIRECTORY
3. FILE
4. DATA\_SUPPLIER

### A.31.5 Example 1 (Typical CD-ROM Volume)

Please see the example in Section A.5 for the CATALOG object.

### A.31.6 Example 2 (Tape Volume)

The following VOLUME object example shows how directories and files are detailed when a volume is stored on an ANSI tape for transfer. This form of the VOLUME object should be used when transferring volumes of data on media which do not support hierarchical directory structures (for example, when submitting a volume of data on tape for mastering to CDROM). The VOLDESC.CAT file will contain the standard volume keywords, but the values of MEDIUM\_TYPE, MEDIUM\_FORMAT and VOLUME\_FORMAT should indicate that the volume is stored on tape.

In this example two files are defined in the root directory of the volume, VOLDESC.CAT and AAREADME.TXT. The first DIRECTORY object defines the CATALOG directory which contains meta data in the included, individual catalog objects. In this example, all the catalog objects are concatenated into a single file, CATALOG.CAT. The second DIRECTORY object defines an INDEX subdirectory containing three files: INDXINFO.TXT, INDEX.LBL, and INDEX.TAB. Following that directory, the first data directory is defined. Note that the SEQUENCE\_NUMBER keyword indicates the physical sequence of the files on the tape volume.

```

PDS_VERSION_ID          = PDS3
OBJECT                  = VOLUME
  VOLUME_SERIES_NAME    = "MISSION TO MARS"
  VOLUME_SET_NAME      = "MARS DIGITAL IMAGE MOSAIC AND DIGITAL
                        TERRAIN MODEL"
  VOLUME_SET_ID        = USA_NASA_PDS_VO_2001_TO_VO_2007
  VOLUMES              = 7
  VOLUME_NAME          = "MDIM/DTM VOLUME 7: GLOBAL COVERAGE"
  VOLUME_ID            = VO_2007
  VOLUME_VERSION_ID    = "VERSION 1"
  PUBLICATION_DATE     = 1992-04-01
  DATA_SET_ID         = "VO1/VO2-M-VIS-5-DTM-V1.0"
  MEDIUM_TYPE          = "8-MM HELICAL SCAN TAPE"
  MEDIUM_FORMAT        = "2 GB"
  VOLUME_FORMAT        = ANSI
  HARDWARE_MODEL_ID    = "VAX 11/750"
  OPERATING_SYSTEM_ID  = "VMS 4.6"

```



```

DESCRIPTION                = "This volume contains the Mars Digital
Terrain Model and Mosaicked Digital Image Model covering the entire
planet at resolutions of 1/64 and 1/16 degree/pixel.  The volume
also contains Polar Stereographic projection files of the north and
south pole areas from 80 to 90 degrees latitude; Mars Shaded Relief
Airbrush Maps at 1/16 and 1/ 4 degree/pixel; a gazetteer of Mars
features; and a table of updated viewing geometry files of the
Viking EDR images that comprise the MDIM."
MISSION_NAME                = VIKING
SPACECRAFT_NAME            = {VIKING_ORBITER_1,VIKING_ORBITER_2}
SPACECRAFT_ID              = {VO1,VO2}

OBJECT                      = DATA_PRODUCER
  INSTITUTION_NAME         = "U.S.G.S. FLAGSTAFF"
  FACILITY_NAME            = "BRANCH OF ASTROGEOLOGY"
  FULL_NAME                = "Eric M. Eliason"
  DISCIPLINE_NAME         = "IMAGE PROCESSING"
  ADDRESS_TEXT             = "Branch of Astrogeology
United States Geological Survey
2255 North Gemini Drive
Flagstaff, Arizona. 86001 USA"
END_OBJECT                 = DATA_PRODUCER

OBJECT                      = CATALOG
  ^CATALOG                = "CATALOG.CAT"
END_OBJECT                 = CATALOG

OBJECT                      = FILE
  FILE_NAME                = "VOLDESC.CAT"
  RECORD_TYPE              = STREAM
  SEQUENCE_NUMBER         = 1
END_OBJECT                 = FILE

OBJECT                      = FILE
  FILE_NAME                = "AAREADME.TXT"
  RECORD_TYPE              = STREAM
  SEQUENCE_NUMBER         = 2
END_OBJECT                 = FILE

OBJECT                      = DIRECTORY
  NAME                     = CATALOG

  OBJECT                  = FILE
    FILE_NAME             = "CATALOG.CAT"
    RECORD_TYPE           = STREAM
    SEQUENCE_NUMBER       = 3
  END_OBJECT              = FILE
END_OBJECT                 = DIRECTORY

OBJECT                      = DIRECTORY
  NAME                     = DOCUMENT

OBJECT                      = FILE

```

```

        FILE_NAME           = "VOLINFO.TXT"
        RECORD_TYPE        = STREAM
        SEQUENCE_NUMBER    = 4
        END_OBJECT

    OBJECT                  = FILE
        FILE_NAME           = "DOCINFO.TXT"
        RECORD_TYPE        = STREAM
        SEQUENCE_NUMBER    = 5
        END_OBJECT
END_OBJECT                = DIRECTORY

OBJECT                    = DIRECTORY
    NAME                   = INDEX

    OBJECT                 = FILE
        FILE_NAME         = "INDXINFO.TXT"
        RECORD_TYPE      = STREAM
        SEQUENCE_NUMBER  = 6
        END_OBJECT

    OBJECT                 = FILE
        FILE_NAME         = "INDEX.LBL"
        RECORD_TYPE      = STREAM
        SEQUENCE_NUMBER  = 7
        END_OBJECT

    OBJECT                 = FILE
        FILE_NAME         = "INDEX.TAB"
        RECORD_TYPE      = FIXED_LENGTH
        RECORD_BYTES     = 512
        FILE_RECORDS     = 6822
        SEQUENCE_NUMBER  = 8
        END_OBJECT
END_OBJECT                = DIRECTORY

OBJECT                    = DIRECTORY
    NAME                   = MG00NXXX

    OBJECT                 = FILE
        FILE_NAME         = "MG00N012.IMG"
        RECORD_TYPE      = FIXED_LENGTH
        RECORD_BYTES     = 964
        FILE_RECORDS     = 965
        SEQUENCE_NUMBER  = 10
        END_OBJECT
END_OBJECT                = DIRECTORY

END_OBJECT                = VOLUME
END

```

### A.31.7 Example 3 (Logical Volumes in an Archive Volume)



```

END_OBJECT                = DATA_PRODUCER

OBJECT                    = CATALOG
  DATA_SET_ID            = "VG2-SR/UR/NR-PPS-4-OCC-V1.0"
  LOGICAL_VOLUME_PATH_NAME = "PPS/"
  ^MISSION_CATALOG        = "MISSION.CAT"
  ^INSTRUMENT_HOST_CATALOG = "INSTHOST.CAT"
  ^INSTRUMENT_CATALOG     = "INST.CAT"
  ^DATA_SET_COLLECTION_CATALOG = "DSCOLL.CAT"
  ^DATA_SET_CATALOG       = "DATASET.CAT"
  ^REFERENCE_CATALOG      = "REF.CAT"
  ^PERSONNEL_CATALOG      = "PERSON.CAT"
END_OBJECT                = CATALOG

OBJECT                    = CATALOG
  DATA_SET_ID            = "VG1/VG2-SR/UR/NR-UVS-4-OCC-V1.0"
  LOGICAL_VOLUME_PATH_NAME = "UVS/"
  ^MISSION_CATALOG        = "MISSION.CAT"
  ^INSTRUMENT_HOST_CATALOG = "INSTHOST.CAT"
  ^INSTRUMENT_CATALOG     = "INST.CAT"
  ^DATA_SET_COLLECTION_CATALOG = "DSCOLL.CAT"
  ^DATA_SET_CATALOG       = "DATASET.CAT"
  ^REFERENCE_CATALOG      = "REF.CAT"
  ^PERSONNEL_CATALOG      = "PERSON.CAT"
END_OBJECT                = CATALOG

OBJECT                    = CATALOG
  DATA_SET_ID            = "VG1/VG2-SR/UR/NR-RSS-4-OCC-V1.0"
  LOGICAL_VOLUME_PATH_NAME = "RSS/"
  ^MISSION_CATALOG        = "MISSION.CAT"
  ^INSTRUMENT_HOST_CATALOG = "INSTHOST.CAT"
  ^INSTRUMENT_CATALOG     = "INST.CAT"
  ^DATA_SET_COLLECTION_CATALOG = "DSCOLL.CAT"
  ^DATA_SET_CATALOG       = "DATASET.CAT"
  ^REFERENCE_CATALOG      = "REF.CAT"
  ^PERSONNEL_CATALOG      = "PERSON.CAT"
END_OBJECT                = CATALOG

END_OBJECT                = VOLUME
END

```

### A.31.7.2 Logical Volumes – Volume Object (logical volume level)

The example below, illustrates the use of the VOLUME object required at the top level of a logical volume. Note that at this level the keywords DATA\_SET\_ID and LOGICAL\_VOLUME\_PATH\_NAME contain only the values relevant to the current logical volume. Also, the keyword LOGICAL\_VOLUMES does not appear here.

```

PDS_VERSION_ID           = PDS3
OBJECT                   = VOLUME
  VOLUME_SERIES_NAME     = "VOYAGERS TO THE OUTER PLANETS"
  VOLUME_SET_NAME        = "PLANETARY RING OCCULTATIONS
                           FROM VOYAGER"

```

```

VOLUME_SET_ID          = "USA_NASA_PDS_VG_3001"
VOLUMES                = 1
MEDIUM_TYPE           = "CD-ROM"
VOLUME_FORMAT          = "ISO-9660"
VOLUME_NAME            = "VOYAGER PPS/UVS/RSS RING
                        OCCULTATIONS"
VOLUME_ID              = "VG_3001"
VOLUME_VERSION_ID     = "VERSION 1"
PUBLICATION_DATE       = 1994-03-01
DATA_SET_ID            = "VG2-SR/UR/NR-PPS-4-OCC-V1.0"
LOGICAL_VOLUME_PATH_NAME = "PPS/"
DESCRIPTION             = "This logical volume contains the
                        Voyager 2 PPS ring occultation data sets. Included are data files at
                        a variety of levels of processing, plus ancillary geometry,
                        calibration and trajectory files plus software and documentation."

OBJECT                 = DATA_PRODUCER
  INSTITUTION_NAME     = "PDS RINGS NODE"
  FACILITY_NAME        = "NASA AMES RESEARCH CENTER"
  FULL_NAME            = "DR. MARK R. SHOWALTER"
  DISCIPLINE_NAME      = "RINGS"
  ADDRESS_TEXT         = "Mail Stop 245-3
                        NASA Ames Research Center
                        Moffett Field, CA 94035-1000"
END_OBJECT             = DATA_PRODUCER

OBJECT                 = CATALOG
  DATA_SET_ID         = "VG2-SR/UR/NR-PPS-4-OCC-V1.0"
  LOGICAL_VOLUME_PATH_NAME = "PPS/"
  ^MISSION_CATALOG     = "MISSION.CAT"
  ^INSTRUMENT_HOST_CATALOG = "INSTHOST.CAT"
  ^INSTRUMENT_CATALOG  = "INST.CAT"
  ^DATA_SET_COLLECTION_CATALOG = "DSCOLL.CAT"
  ^DATA_SET_CATALOG    = "DATASET.CAT"
  ^REFERENCE_CATALOG   = "REF.CAT"
  ^PERSONNEL_CATALOG   = "PERSON.CAT"
END_OBJECT             = CATALOG

END_OBJECT             = VOLUME
END

```

**A**

AAREADME.TXT, A-144  
ALIAS object  
    definition, A-3  
ARRAY object, A-1, A-36  
    definition, A-4  
ASCII tables, A-124  
AXIS\_ITEMS, A-4  
AXIS\_NAME, A-80

**B**

BAND\_BIN, A-78  
BAND\_STORAGE\_TYPE, A-65  
BANDS, A-65  
binary tables, A-127  
    spare bytes, A-127  
BIT\_COLUMN object, A-18, A-127  
    definition, A-8  
BIT\_ELEMENT object, A-1  
    definition, A-11  
BYTES, A-16, A-55, A-124

**C**

CATALOG object  
    definition, A-12  
CHECKSUM, A-67  
COLLECTION object, A-1, A-4, A-6, A-36  
    definition, A-15  
COLUMN object, A-3, A-8, A-85, A-123  
    and CONTAINER, A-20  
    definition, A-16  
    vectors, A-16  
CONTAINER object, A-16  
    definition, A-20  
    in TABLE, A-139

**D**

data objects, A-1  
    ALIAS, A-3  
    ARRAY, A-4

BIT\_COLUMN, A-8  
 BIT\_ELEMENT, A-11  
 CATALOG, A-12  
 COLLECTION, A-15  
 COLUMN, A-16  
 CONTAINER, A-20  
 DATA\_PRODUCER, A-27  
 DATA\_SUPPLIER, A-29  
 DIRECTORY, A-31  
 DOCUMENT, A-33  
 ELEMENT, A-36  
 FIELD, A-38  
 FILE, A-41  
 GAZETTEER\_TABLE, A-45  
 HEADER, A-55  
 HISTOGRAM, A-57  
 HISTORY, A-60  
 IMAGE, A-64, A-74  
 INDEX\_TABLE, A-69  
 PALETTE, A-74  
 QUBE, A-77  
 SERIES, A-85  
 SPECTRAL\_QUBE, A-90  
 SPECTRUM, A-112  
 SPICE\_KERNEL, A-115  
 SPREADSHEET, A-118  
 TABLE, A-123  
 TEXT, A-144  
 VOLUME, A-146  
 DATA\_PRODUCER object, A-29  
   definition, A-27  
 DATA\_SET object, A-41  
 DATA\_SET\_ID, A-150, A-151  
 DATA\_SUPPLIER object, A-27  
   definition, A-29  
 DIRECTORY object, A-147  
   definition, A-31  
 DOCINFO.TXT, A-144  
 document  
   ASCII version, A-33  
 DOCUMENT object  
   definition, A-33  
 documentation  
   file labelling  
     DOCUMENT object, use of, A-33  
 documents

and DOCUMENT object, A-33

**E**

ELEMENT object, A-1, A-6  
definition, A-36

**F**

field delimiters, A-142  
FIELD object  
definition, A-38  
example, A-39, A-40  
in SPREADSHEET, A-38  
FILE object, A-31  
definition, A-41  
implicit, A-41  
table of required and optional elements, A-42  
FILE\_NAME, A-41  
FILE\_STATE, A-78

**G**

GAZETTEER\_TABLE object  
definition, A-45  
GROUP  
in HISTORY object, A-60  
in QUBE, A-78

**H**

HEADER object, A-132  
definition, A-55  
HISTOGRAM object, A-78  
definition, A-57  
HISTORY object  
and QUBE, A-78  
definition, A-60

**I**

IMAGE object, A-74, A-78  
and PALETTE, A-74  
definition, A-64  
stored with TABLE object, A-138  
IMAGE\_MAP\_PROJECTION object, A-78  
INDEX\_TABLE



contents, A-69  
 INDEX\_TABLE object  
   definition, A-69  
 INDEX\_TYPE, A-69  
 Integrated Software for Imagers and Spectrometers (ISIS), A-107  
 INTERCHANGE\_FORMAT, A-123  
 ISIS Software  
   QUBE object, A-77  
 ITEM\_BITS, A-8  
 ITEM\_BYTES, A-16  
 ITEM\_OFFSET, A-8, A-16  
 ITEMS, A-8, A-16

<b>K</b>
----------

KERNEL\_TYPE  
   table of file extensions, A-115

<b>L</b>
----------

line terminators and delimiters  
   vis-a-vis byte counts in objects  
     exclusion of line terminators and delimiters in objects, A-16  
 LINE\_DISPLAY\_DIRECTION, A-65  
 LINE\_PREFIX\_BYTES, A-64  
 LINE\_SAMPLES, A-64  
 LINE\_SUFFIX\_BYTES, A-64  
 LINES, A-64  
 LOGICAL\_VOLUME\_PATH\_NAME, A-150, A-151  
 LOGICAL\_VOLUMES, A-150, A-151

<b>M</b>
----------

MAXIMUM\_SAMPLING\_PARAMETER, A-85  
 MEDIUM\_FORMAT, A-147  
 MEDIUM\_TYPE, A-147  
 MINIMUM\_SAMPLING\_PARAMETER, A-85

<b>N</b>
----------

NAIF Toolkit, A-115  
 NAME, A-41

<b>O</b>
----------

object definitions  
   URL, A-1

objects. *See* data object. *See* catalog objects

**P**

PALETTE object, A-78  
definition, A-74  
PDS objects. *See* data objects. *See* catalog objects  
prefix or suffix data  
in QUBE object, A-83  
in TABLE object, A-139, A-143  
primitive data objects, A-1  
primitive objects  
ARRAY, A-4  
BIT\_ELEMENT, A-11  
COLLECTION, A-15  
ELEMENT, A-36  
PRODUCT\_ID, A-115

**Q**

QUBE  
SPECTRAL\_QUBE, A-90  
QUBE object  
and HISTORY object, A-78  
definition, A-77

**R**

RECORD\_BYTES, A-130  
RECORD\_TYPE, A-42  
REPETITIONS, A-21  
ROW\_BYTES, A-130  
ROW\_PREFIX\_BYTES, A-64, A-86  
use, A-138  
ROW\_SUFFIX\_BYTES, A-64  
use, A-138

**S**

SAMPLE, A-74  
SAMPLE\_BITS, A-64  
SAMPLE\_DISPLAY\_DIRECTION, A-65  
SAMPLE\_TYPE, A-64  
sampling parameter data  
in SERIES object, A-89  
SAMPLING\_PARAMETER\_INTERVAL, A-85  
SCALING\_FACTOR, A-67

SEQUENCE\_NUMBER, A-31, A-147  
 sequential media, A-31  
 SERIES object, A-16, A-130  
     definition, A-85  
     TIME\_SERIES, A-85  
     use of spare fields, A-143  
 SOFTINFO.TXT, A-144  
 SOURCE\_PRODUCT\_ID, A-115  
 SPARE bytes, A-127, A-139  
 spare fields  
     use in TABLE, SPECTRUM and SERIES objects, A-143  
 SPECTRAL\_CUBE  
     compatibility with ISIS, A-107  
     labeling, A-97  
 SPECTRAL\_CUBE object definition, A-90  
 SPECTRUM object, A-16, A-130  
     definition, A-112  
     use of spare fields, A-143  
 SPICE kernels  
     labelling, A-115  
 SPICE system  
     kernel file extensions, A-115  
 SPICE\_KERNEL object  
     definition, A-115  
 SPREADSHEET object  
     CSV file format, A-119  
     definition, A-118  
     example, A-120  
     field delimiters, A-119  
     formats, A-119  
 START\_BYTE, A-4, A-15, A-36, A-124  
 START\_TIME, A-85  
 STOP\_TIME, A-85  
 STRUCTURE pointer, A-128

<b>T</b>
----------

TABLE object, A-16, A-64, A-78  
     and CONTAINER, A-139  
     ASCII field delimiters, A-142  
     ASCII tables, A-124  
     binary tables, A-127  
     definition, A-123  
     INDEX\_TABLE, A-69  
     more than one in a single file, A-136  
     PALETTE, A-74  
     SERIES object, A-85

- SPARE bytes, A-127, A-139
- SPECTRUM object, A-112
  - stored with IMAGE object, A-138
- STRUCTURE pointer, A-128
  - use of spare fields, A-143
  - variations, A-130
- tables
  - multiple tables in single file, A-136
- text
  - plain text formatting, A-144
- TEXT object
  - definition, A-144

---

**V**

---

- VICAR headers, A-55
- VOLDESC.CAT, A-12, A-147
- VOLINFO.TXT, A-144
- VOLUME object, A-12, A-27, A-29, A-31, A-41, A-150
  - definition, A-146
- VOLUME\_FORMAT, A-147